



**Makita**<sup>®</sup>



**PROMOFOLDER**  
01/10/2023 - 31/03/2024

HERDRUK  
JANUARI 2024

## NIEUWIGHEDEN













Artikel	Pagina
TD002GZ04	6
HR010GZ01	7
GA050GZ	11
CE002GZ01	12
JV001GZ01	16
JV001GM201	16
ADP12	21
CF003GZ	22
CW004GZ	23
DF489RTJ	29
DHP489RTJ	29
DBO484ZJ	42
DBO382ZJ	42
DMC300ZJ	45
DMC300RTJ	45
DF489ZJ	54
DHP489ZJ	54
DCX200C	57
DCX201C	57
RP2302FC07	92
HW001GZ	107
DDG461Z	108
DG002GZ	108

## PROMOTIES

Artikel	Promotie	Pagina
DF001GM201	E-05337 + E-05094	5
HP001GM201	E-05337 + E-05094	5
TD001GD201	DEAML006G	6
TD001GM201	DEAML006G	6
TW007GD201	E-16586	10
CE001GZ	E-12996	12
LS002GZ01	DEBWST06	17
LS004GZ01	DEBWST06	17
LS003GZ01	DEBWST06	17
DK0114G201	BL4025	18
DK0124G201	BL4025	18
DK0125G301	BL4040	18
DK0126G401	BL4040 + DC40RA	19
DK0128G601	191J97-1	19
DHR243RTJ	BL1850B	30
DHR243Z	D-42444	30
DHR243T1J	D-42444	30
DTW300RTJ	E-08458	33
DTD153RTJ	194281-7	35
DHS680RTJ	BL1850B	38
DBO380RTJ	BL1830B	42
DBO381RTJU	BL1830B	42
DCE090ZX1	E-03006-25	45
DCE090T2X1	E-03006-25	45
DGA506T1J	D-18770-10	46
DGA508T1J	D-18770-10	46
DGA506RTJ	BL1830B	46
DGA508RTJ	BL1830B	46
DTR180ZJ	191A57-9	48
DLX2289T3J	BL1830B	51
DLX2189T3J	BL1830B	51
DLX2440TJ	BL1830B	51
DLX2236TJ1	BL1830B	51
DLX2235T3J	BL1830B	51
DLX2434TJ	BL1830B	51
DLX2194PTJ	BL1830B	51
DLX2245PT1	BL1830B	51
DLX2418TJ	BL1830B	53
DLX4159TJ	2X BL1830B	53
DLX5070TJ	2X BL1830B	53
DLX5071TJ	2X BL1830B	53
DLX6115X1	3X BL1830B	53
DLX1036TJ1	3X BL1830B	53
DLX1108TJ1	3X BL1830B	53
CLX228SAX2	DEAML103	62
DCL182Z	199491-1 + 199971-7	68
DCL280FZW	191D71-3 + 199971-7	68
DVC863LZ	2X BL1830B	74
HR4013C	P-52445	78
HR4511C	P-52445	78
HR5212C	P-52445	78
HM0871C	E-20236	79
HM1812	D-54972	80
LS1019	DEBWST06	95
LS1219	DEBWST06	95
SKR200Z	P-81315	99
SK105DZ	BL1021B + DC10SB	100
SK105GDZ	BL1021B + DC10SB	100
SK106DZ	BL1021B + DC10SB	100
SK106GDZ	BL1021B + DC10SB	100
SK10GDZ	197658-5	100
SK20GDZ	197658-5	100
SK40GDZ	197658-5	100
SK209GDZ	197658-5	100
SK312GDZ	197658-5	100
SK700DZ	197658-5	101
SK700GDZ	197658-5	101
DUC256Z001	E-08458	103
DUC356Z001	E-08458	103
DUC406Z001	E-08458	103
DUC306Z001	E-08458	103
UM600DSAEX	831253-8	103
DUM604RFEX	831253-8	103
DUM111SYX	831253-8	103
DCU180Z	199009-8	105

## COMBOPACKS

Artikel	Pagina
Combopacks XGT	18-19
Combopacks LXT	51-53
Combopacks CXT	62
Combopacks slijpers	51,88
Combopacks zaagmachines	38,93
Combopacks tuin	102

	Accu gereedschap	5
	Stofzuigers	68
	Boor- en breekhamers	77
	Boormachines	81
	Bevestiging	82
	Metaal	83
	Slijpers	84
	Beton	89
	Hout	90
	Pneumatisch gereedschap	98
	Lasers	99
	Tuingereedschap	102

## MAKITA WERKT VOLGENS DE RICHTLIJNEN VAN DE EPTA



EPTA staat voor European Power Tool Association en is een vereniging van de belangrijkste fabrikanten van powertools. De EPTA stelt verplichte richtlijnen op, waardoor uniforme en vergelijkbare specificaties en gegevens gegarandeerd worden. Zo zijn er richtlijnen voor het gewicht (zonder snoer maar met alle machine toebehoren die voor het normale gebruik noodzakelijk zijn), voor slagkracht, enz.

In het verleden had iedere fabrikant zijn eigen norm, daarom waren de gegevens voor de invoering van EPTA, van fabrikant tot fabrikant verschillend en niet met elkaar vergelijkbaar.

Om u zo correct mogelijk te informeren, meet Makita uitsluitend volgens de richtlijnen van de EPTA. In al onze media (catalogi, folders, website, enz.) worden daarom enkel waarden conform de EPTA-richtlijnen gebruikt.

**XGT**

# 40V **Li-ion** max



## Next Generation Technology

XGT is een nieuw platform met specifieke machines, accu's en laders. De combinatie van Makita's bewezen motortechnologie, geavanceerde elektronische sturing en kwalitatieve 40Vmax-batterijen biedt een geweldig alternatief voor de meest veeleisende gebruiker. Het XGT-platform vult het bestaande CXT- en LXT platform aan maar vervangt deze niet. Het is de volgende, logische stap naar een snoerloze toekomst en zorgt voor een oplossing op accu voor de zwaarste toepassingen.

## Digitale communicatie

Op het XGT-platform kunnen de machines en accu's nu ook onderling digitaal communiceren via geïntegreerde elektronica. Dat resulteert in een perfect energiemangement, optimale prestaties en bovendien een effectieve bescherming van alle componenten bij extreme belasting.

## Optimaal laden

Digitaal geoptimaliseerd laadtraject met twee ventilatoren voor een perfecte temperatuurcontrole en continue actieve bijsturing van het laadtraject. Het resultaat zijn nog snellere laadtijden en een langere levensduur van de batterijen.



# De nieuwste innovatie in accugereedschap



**KRACHTIG**



**TOEKOMST-GERICHT**



**INTELLIGENT**



**BETROUW-BAAR**

ACCU (KLOP-)BOOR- EN SCHROEFMACHINES



## HP001G / DF001G

- Maximaal koppel tot 140 Nm
- Tot 35 % hogere snelheid
- Bestand tegen continu werken onder hoge belasting

HP / DF001 G	135
LXT 18 V	100

Laag Snelheid Hoog

**Tot 35 % hogere rotatiesnelheid en meer koppel**  
Maakt het mogelijk om meer werk te verrichten op kortere tijd.



**41 elektronische koppelinstellingen**  
Voor een groter instelbereik en grotere nauwkeurigheid.

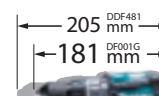

**Uiterst compact**  
In vergelijking met de LXT-variant 24 mm korter.



**Active Feedback sensing Technology**  
Schakelt de machine uit bij een plotse zwenkbeweging.

DF001GM201 & HP001GM201: gratis gereedschapsriem E-05337 + holster E-05094

	DF001GZ01	DF001GM201	DF002GZ01	DF002GD201	HP001GZ01	HP001GM201	HP002GZ01	HP002GD201	
Spanning	36 V (40Vmax)	36 V (40Vmax)	36 V (40Vmax)	36 V (40Vmax)	36 V (40Vmax)	36 V (40Vmax)	36 V (40Vmax)	36 V (40Vmax)	
Bijgeleverde accu's	0	2 x BL4040	0	2 x BL4025	0	2 x BL4040	0	2 x BL4025	
Lader	-	DC40RA	-	DC40RA	-	DC40RA	-	DC40RA	
Max. koppel zacht / hard	68 / 140 Nm	68 / 140 Nm	30 / 64 Nm	30 / 64 Nm	68 / 140 Nm	68 / 140 Nm	30 / 64 Nm	30 / 64 Nm	
Boorkop	1,5 - 13 mm	1,5 - 13 mm	1,5 - 13 mm	1,5 - 13 mm	1,5 - 13 mm	1,5 - 13 mm	1,5 - 13 mm	1,5 - 13 mm	
Klopboorfunctie	-	-	-	-	✓	✓	✓	✓	
Gewicht	2,7 kg	2,7 kg	2,5 kg	2,5 kg	2,7 kg	2,7 kg	2,6 kg	2,6 kg	
Prijs in €	excl. btw	€ 275,00	€ 739,00	€ 175,00	€ 535,00	€ 285,00	€ 739,00	€ 185,00	€ 549,00
	incl. btw	€ 332,75	€ 894,19	€ 211,75	€ 647,35	€ 344,85	€ 894,19	€ 223,85	€ 664,29

# NEMESIS

# Makita

WWW.MAKITA.BE

## 4-snijder hamerboren met lasergelaste hardmetalen boorpunt

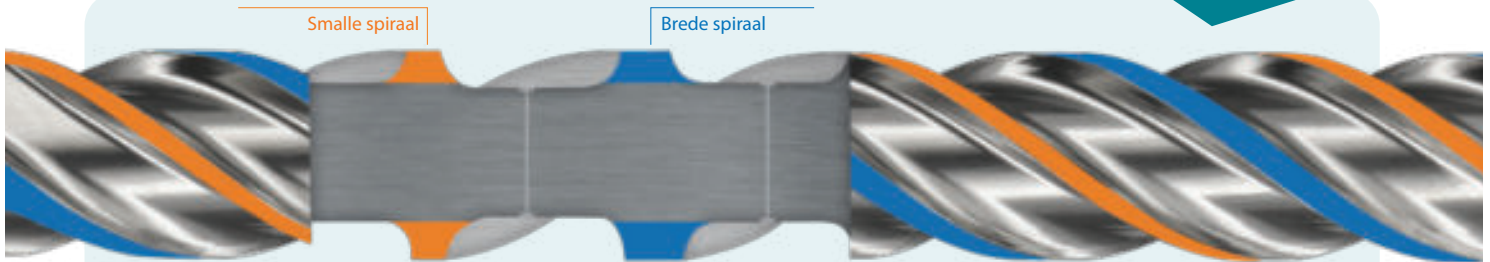

Smalle spiraal

Brede spiraal

Verhoogde snelheid

Heavy duty design

### Hogere Snelheid

- > De smalle spiraal zorgt voor minder wrijving en snellere boorprestaties!
- > Vlottere afvoer van het boorgruis dankzij het lasergelaste boorpunt en de dubbele spiraal.
- > Lasergelaste carbide boorpunten t.e.m. Ø 16 mm.

### Zware klus

- > De brede spiraal zorgt voor een structurele versterking van de kern en minder last van slijtage.
- > Dankzij het robuust ontwerp is de Nemesis II-boor veilig, geschikt voor de zwaaste klus en loopt ze niet vast op betonstaal.

### Langere levensduur

- > Verhoogde weerstand tegen oververhitting dankzij het lasergelaste boorpunt.
- > Het solide uit 1 stuk vervaardigd hardmetalen boorpunt zorgt voor lage vibraties en optimale boorprestaties.



ACCU SLAGSCHROEVENDRAAIERS



BL MOTOR

XGT 40V Li-Ion max

### TD002G

- Hamermechanisme met een dubbele veer, dit levert meer comfort op over een groot bereik van toepassingen van licht tot zwaar werk.
- Uitstekende verlichting van het werkstuk met 4 LED's



TD003GZ01



TD002GZ04



TD001GD201

Promo: gratis DEAML006G bij TD001GD201 en TD001GM201

### TD003G

- Minder extra functies dan TD001G/TD002G maar uitstekende prijs/kwaliteitsverhouding
- Eenvoudige keuze van het slagenergie: 4 modi en één T-modus (voor het schroeven van zelftappende schroeven in dun metaal)



NIEUW

	TD003GZ01	TD001GZ02	TD001GD201	TD001GM201	TD002GZ04	
Spanning	36 V (40Vmax)	36 V (40Vmax)	36 V (40Vmax)	36 V (40Vmax)	36 V (40Vmax)	
Bijgeleverde accu's	-	-	2 x BL4025	2 x BL4040	-	
Lader	-	-	DC40RA	DC40RA	-	
Bitopname	1/4 " hex	1/4 " hex	1/4 " hex	1/4 " hex	1/4 " hex	
Max. koppel	210 Nm	220 Nm	220 Nm	220 Nm	220 Nm	
Slagkrachtniveaus	4	4	4	4	4	
Hulpfuncties	1	6	6	6	6	
Gewicht	1,7-2,9 kg	1,7-2,9 kg	1,7-2,9 kg	1,7-2,9 kg	1,7-2,9 kg	
Prijs in €	excl. btw	€ 199,00	€ 269,00	€ 629,00	€ 729,00	€ 309,00
	incl. btw	€ 240,79	€ 325,49	€ 761,09	€ 882,09	€ 373,89

# NEXT GENERATION TECHNOLOGY

## ACCU HAAKSE BOORMACHINE



DA001GM101

- Zeer hoog koppel (136 Nm)
- Twee mechanische snelheden
- Ingebouwde mechanische slipkoppeling

	DA001GZ01	DA001GM101
Spanning	36 V (40Vmax)	36 V (40Vmax)
Bijgeleverde accu's	-	1 x BL4040
Bijgeleverde lader	-	DC40RA
Toerental	0 - 400 t.p.m. 0 - 1500 t.p.m.	0 - 400 t.p.m. 0 - 1500 t.p.m.
Hard koppel	70/136 Nm	70/136 Nm
Boorkop	13 mm	13 mm
Gewicht	5,3 - 6,2 kg	5,3 - 6,2 kg
Prijs in €	excl. btw	€ 545,00
	incl. btw	€ 659,45

## ACCU COMBIHAMERS SDS-PLUS



### HR010G

- Licht, compact en toch krachtig
- Speciale behuizing en handgreep reduceren de trillingen
- Optioneel verkrijgbaar: DX16 stofafzuigingsunit
- De perfecte oplossing voor de kleinere diameters!



HR010GZ01



HR007GM201



HR002GM204



HR009GZ02

### NIEUW

	HR010GZ01	HR007GZ01	HR007GM201	HR002GZ02	HR002GM204	HR009GZ02	HR009GM202
Spanning	36 V (40Vmax)	36 V (40Vmax)	36 V (40Vmax)	36 V (40Vmax)	36 V (40Vmax)	36 V (40Vmax)	36 V (40Vmax)
Bijgeleverde accu's	-	-	2 x BL4040	-	2 x BL4040	-	2 x BL4040
Lader	-	-	DC40RA	-	DC40RA	-	DC40RA
Slagenergie	2,0 J	3,0 J	3,0 J	2,9 J	2,9 J	3,9 J	3,9 J
Max. Ø beton	20 mm	28 mm	28 mm	28 mm	28 mm	30 mm	30 mm
Trillingsniveau (ah)	10,0 m/s <sup>2</sup>	7,5 m/s <sup>2</sup>	7,5 m/s <sup>2</sup>	6,0 m/s <sup>2</sup>	6,0 m/s <sup>2</sup>	9,1 m/s <sup>2</sup>	9,1 m/s <sup>2</sup>
Stofafzuigingsunit	DX16: optioneel	DX15: optioneel	DX15: optioneel	DX14: optioneel	DX14: inbegrepen	DX11: inbegrepen	DX11: inbegrepen
AWS	✓ (excl. Bluetooth unit)	✓ (excl. Bluetooth unit)	✓ (excl. Bluetooth unit)	✓	✓	✓ (excl. Bluetooth unit)	✓ (excl. Bluetooth unit)
Gewicht	2,9 - 4,5 kg	3,8 - 4,8 kg	3,8 - 4,8 kg	4,1 - 4,6 kg	4,1 - 4,6 kg	5,3 - 6,7 kg	5,3 - 6,7 kg
Prijs in €	excl. btw	€ 299,00	€ 359,00	€ 825,00	€ 479,00	€ 1.095,00	€ 649,00
	incl. btw	€ 361,79	€ 434,39	€ 998,25	€ 579,59	€ 1.324,95	€ 785,29

## AFT Active feedback sensing technology

Deze technologie schakelt de motor onmiddellijk uit bij het plots blokkeren van de machine. De HR002G, HR007G en HR009G maken daarbij gebruik van een accelerometer die de zwenkbeweging van de machine detecteert. De AFT-technologie verhoogt de veiligheid enorm.



## HR005G

- Uitstekende vermogen/gewichtsverhouding
- Beveiliging tegen terugslag (AFT met accelerometer)
- Actieve trillingsdemping (AVT)

Slagenergie  
**8,0 J**



HR005GM202

## HR006G

- 2 x 40Vmax accu's in serie zorgen voor extreme kracht
- Beveiliging tegen terugslag (AFT met accelerometer)
- Actieve trillingsdemping (AVT)



HR006GZ

Slagenergie  
**20,0 J**



	HR005GZ01	HR005GM202	HR006GZ
Spanning	36 V (40 V <sub>max</sub> )	36 V (40 V <sub>max</sub> )	2 x 36 V (40 V <sub>max</sub> )
Bijgeleverde Accu's	-	2 x BL4040	-
Slagenergie	8,0 J	8,0 J	20,0 J
Slagfrequentie	1450 - 2900 min <sup>-1</sup>	1450 - 2900 min <sup>-1</sup>	1100 - 2250 min <sup>-1</sup>
Trillingsniveau (ah)	5 m/s <sup>2</sup>	5 m/s <sup>2</sup>	8,5 m/s <sup>2</sup>
Capaciteit beton	40 mm	40 mm	52 mm
Toerental onbelast	250 - 500 min <sup>-1</sup>	250 - 500 min <sup>-1</sup>	250 - 310 min <sup>-1</sup>
AWS	✓	✓	✓ (excl. Bluetooth unit)
Gewicht	7,4 kg - 8,2 kg	7,4 kg - 8,2 kg	12,9 - 14,3 kg
Prijs in €	excl. btw	€ 845,00	€ 1.309,00
	incl. btw	€ 1.022,45	€ 1.583,89
			€ 1.079,00
			€ 1.305,59



# NEXT GENERATION TECHNOLOGY

ACCU BREEKHAMERS SDS-MAX

BL  
MOTOR

XGT  
40V  
Lithium  
max

XGT X2  
80V  
max

## HM001G



- Evenaart de kracht van modellen op netstroom
- Hoge slagenergie (9,4 J)
- Uitzonderlijk laag trillingsniveau dankzij actieve trillingsdemping (AVT) en een anti-vibratie behuizing



HM001GM205

Slagenergie  
**9,4 J**



HM002GZ03

Slagenergie  
**20,0 J**

## HM002G



- Extreem krachtig dankzij twee 40Vmax accu's in serie
- Zeer hoge slagenergie (20 J)
- Uitzonderlijk laag trillingsniveau dankzij actieve trillingsdemping (AVT) en een anti-vibratie behuizing

	HM001GZ04	HM001GM205	HM002GZ03
Spanning	36 V (40Vmax)	36 V (40Vmax)	2 x 36 V (40Vmax)
Bijgeleverde accu's	-	2 x BL4040	-
Bijgeleverde lader	-	DC40RA	-
Slagenergie	9,4 J	9,4 J	20 J
Slagfrequentie	0 - 2650 min <sup>-1</sup>	0 - 2650 min <sup>-1</sup>	950 - 1900 min <sup>-1</sup>
Triax. vibratie beitelten (ah)	6,0 m/s <sup>2</sup>	6,0 m/s <sup>2</sup>	8,0 m/s <sup>2</sup>
AWS	✓	✓	✓ excl. Bluetooth unit
Gewicht	6,3 - 7,1 kg	6,3 - 7,1 kg	12,0 - 13,3 kg
Prijs in €	excl. btw	€ 535,00	€ 995,00
	incl. btw	€ 647,35	€ 1.203,95
		€ 775,00	€ 937,75

## ACCU MINIBRADPISTOOL 18 GA



FN001GZ02

	FN001GZ02	FN001GA202
Spanning	36 V (40Vmax)	36 V (40Vmax)
Bijgeleverde accu's	-	2x BL4020
Bijgeleverde lader	-	DC40RA
Lengte nagels	15 - 40 mm	15 - 40 mm
Capaciteit magazijn	100	100
Makpac	✓	✓
Gewicht	2.6 - 3.2 kg	2.6 - 3.2 kg
Prijs in €	excl. btw	€ 445,00
	incl. btw	€ 538,45
Prijs in €	excl. btw	€ 779,00
	incl. btw	€ 942,59

## ACCU PINPISTOOL 23 GA



PT001GZ01

- Werkt sneller dankzij BL motor en herontworpen indrijvingsveer
- Mechanisme met bewegend tegengewicht voor lage terugslag

	PT001GZ01	PT001GD101
Spanning	36 V (40Vmax)	36 V (40Vmax)
Bijgeleverde accu's	-	1x BL4025
Bijgeleverde lader	-	DC40RA
Lengte nagels	15 - 35 mm	15 - 35 mm
Capaciteit magazijn	120	120
Makpac	✓	✓
Gewicht	2.4 - 3.0 kg	2.4 - 3.0 kg
Prijs in €	excl. btw	€ 445,00
	incl. btw	€ 538,45
Prijs in €	excl. btw	€ 679,00
	incl. btw	€ 821,59

## ACCU SLAGMOERSLEUTELS



TW001G

BL-motor



TW004GD201



TW007GD201



Robuust slagmechanisme



Promo: gratis 14-delige doppenset IMPACT BLACK E-16586 bij TW007GD201



Uiterst compact



3 hulpfuncties voor het automatisch stoppen van de rotatie, zowel bij het vastdraaien als het losdraaien.

## HULPFUNCTIES VOOR HET VASTDRAAIEN EN LOSDRAAIEN VAN BOUTEN

	Rechtsom (vastdraaien)	Linksom (losdraaien)
Bouffunctie	Deze functie helpt om continu schroeven erin te draaien met hetzelfde aandraaimoment. Deze functie helpt ook de kans te verkleinen dat de bouten/ moeren breken als gevolg van te strak vastdraaien.	Deze functie helpt voorkomen dat een bout eraf valt. Bij het losdraaien van een bout, zal het gereedschap automatisch stoppen of langzamer gaan draaien zodra de bout/moer voldoende los zit.
<b>mode 1</b>	Het gereedschap stopt automatisch zodra de slagwerking is begonnen.	Het gereedschap stopt automatisch zodra de slagwerking is gestopt.
<b>mode 2</b>	Het gereedschap stopt automatisch ongeveer 0,5 seconde na het moment waarop de slagwerking is begonnen.	Het gereedschap stopt automatisch ongeveer 0,2 seconde na het moment waarop de slagwerking is gestopt.
<b>mode 3</b>	Het gereedschap stopt automatisch ongeveer 1 seconde na het moment waarop de slagwerking is begonnen.	Het gereedschap gaat langzamer draaien nadat de slagwerking is gestopt.

	TW004GZ	TW004GD201	TW007GZ01	TW007GD201	TW001GZ01
Spanning	36 V (40Vmax)	36 V (40Vmax)	36 V (40Vmax)	36 V (40Vmax)	36 V (40Vmax)
Bijgeleverde accu's	0	2 x BL4025	0	2x BL4025	0
Bijgeleverde lader	-	DC40RA	-	DC40RA	-
Toerental	0-3200 tpm	0-3200 tpm	600-2300 tpm	600-2300 tpm	0-1800 tpm
Max. koppel	350 Nm	350 Nm	760 Nm	760 Nm	1800 Nm
Dopaansluiting	1/2"	1/2"	1/2"	1/2"	3/4"
Verpakking	-	Makpac	Makpac	Makpac	Makpac
Gewicht	1,9 - 2,2 kg	1,9 - 2,2 kg	2,7 - 3,3 kg	2,7 - 3,3 kg	3,9 - 4,2 kg
Prijs in €	excl. btw	€ 255,00	€ 635,00	€ 339,00	€ 689,00
	incl. btw	€ 308,55	€ 768,35	€ 410,19	€ 833,69
Prijs in €	excl. btw	€ 379,00	€ 379,00	€ 379,00	€ 379,00
	incl. btw	€ 458,59	€ 458,59	€ 458,59	€ 458,59

# NEXT GENERATION TECHNOLOGY

ACCU HAAKSE SLIJPERS 125 MM



## GA050G

- Compact, zeer hoog vermogen en hoog toerental
- Speciale motorbehuizing in één stuk en trillings-absorberende rubbers tussen de binnen- en buitenkant
- Vernieuwd ontwerp met kleine greepomtrek



GA023GM201



GA050GZ

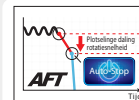

**Active Feedback sensing Technology**  
Schakelt de motor uit bij het plots blokkeren van de schijf

STOFAFZUIGING VOOR SLIJPERS



191F81-2

€ 54,70 excl. btw  
€ 66,19 incl. btw



191G06-2

€ 99,20 excl. btw  
€ 120,03 incl. btw

### Gereedschapsloze beschermkap

- Er is geen gereedschap nodig om de kap te monteren of te verwijderen.
- De beschermkap kan via een kliksysteem in de gewenste stand geplaatst worden.

NIEUW

	GA005GZ01	GA005GM201	GA013GZ01	GA013GM201	GA050GZ	GA023GZ	GA023GM201	GA029GZ	GA029GM201	
Spanning	36 V (40Vmax)	36 V (40Vmax)	36 V (40Vmax)	36 V (40Vmax)	36 V (40Vmax)	36 V (40Vmax)	36 V (40Vmax)	36 V (40Vmax)	36 V (40Vmax)	
Bijgeleverde accu's	0	2 x BL4040	0	2 x BL4040	-	0	2 x BL4040	0	2 x BL4040	
Bijgeleverde lader	-	DC40RA	-	DC40RA	-	-	DC40RA	-	DC40RA	
Toerental onbelast	8500 t.p.m.	8500 t.p.m.	8500 t.p.m.	8500 t.p.m.	11000 t.p.m.	3000 - 8500 t.p.m.	3000 - 8500 t.p.m.	3000 - 8500 t.p.m.	3000 - 8500 t.p.m.	
Regelbaar toerental	-	-	-	-	-	✓	✓	✓	✓	
Type schakelaar	Schuifschakelaar met vergrendeling	Schuifschakelaar met vergrendeling	Lepelschakelaar zonder vergrendeling	Lepelschakelaar zonder vergrendeling	Lepelschakelaar zonder vergrendeling	Schuifschakelaar met vergrendeling	Schuifschakelaar met vergrendeling	Lepelschakelaar zonder vergrendeling	Lepelschakelaar zonder vergrendeling	
AWS	-	-	-	-	-	✓	✓	✓	✓	
Verpakking	Makpac	Makpac	Makpac	Makpac	-	-	Makpac	-	Makpac	
Gewicht	3,0 kg	3,0 kg	3,0 kg	3,0 kg	3,0 kg	3,0 kg	3,0 kg	3,0 kg	3,0 kg	
Prijs in €	excl. btw	€ 245,00	€ 699,00	€ 255,00	€ 715,00	€ 275,00	€ 245,00	€ 725,00	€ 255,00	€ 735,00
	incl. btw	€ 296,45	€ 845,79	€ 308,55	€ 865,15	€ 332,75	€ 296,45	€ 877,25	€ 308,55	€ 889,35

ACCU HAAKSE SLIJPERS 125 MM X-LOCK



## X-LOCK

Snel en veilig schijven bevestigen via een kliksysteem.



GA044GM201



191G05-4  
STOFAFZUIGKAP X-LOCK  
€ 99,20 excl. btw  
€ 120,03 incl. btw

	GA041GZ	GA041GM201	GA044GZ	GA044GM201	GA047GZ	GA047GM201	
Spanning	36 V (40Vmax)	36 V (40Vmax)	36 V (40Vmax)	36 V (40Vmax)	36 V (40Vmax)	36 V (40Vmax)	
Bijgeleverde accu's	-	2x BL4040	-	2x BL4040	-	2x BL4040	
Bijgeleverde lader	-	DC40RA	-	DC40RA	-	DC40RA	
Schijfdiameter	125 mm	125 mm	125 mm	125 mm	125 mm	125 mm	
Toerental onbelast	3.000 - 8.500 min <sup>-1</sup>	3.000 - 8.500 min <sup>-1</sup>	3.000 - 8.500 min <sup>-1</sup>	3.000 - 8.500 min <sup>-1</sup>	8.500 min <sup>-1</sup>	8.500 min <sup>-1</sup>	
Slijpdiepte	31 mm	31 mm	31 mm	31 mm	31 mm	31 mm	
Type schakelaar	Schuifschakelaar	Schuifschakelaar	Lepelschakelaar	Lepelschakelaar	Lepelschakelaar	Lepelschakelaar	
Dodemansschakelaar	-	-	✓	✓	✓	✓	
AWS	✓	✓	✓	✓	-	-	
Verpakking	-	Makpac	-	Makpac	-	Makpac	
Gewicht	3,0 - 5,3 kg	3,0 - 5,3 kg	3,0 - 5,3 kg	3,0 - 5,3 kg	3,0 - 5,3 kg	3,0 - 5,3 kg	
Prijs in €	excl. btw	€ 299,00	€ 785,00	€ 309,00	€ 795,00	€ 285,00	€ 775,00
	incl. btw	€ 361,79	€ 949,85	€ 373,89	€ 961,95	€ 344,85	€ 937,75

## CE001G

- Uiterst krachtig dankzij 2x 40Vmax technologie
- Met soft start, AFT en elektrische rem
- Geïntegreerde watertoevoer
- XPT en Wetguard (IPX4) bescherming
- De combinatie van AVT technologie en een trillingsabsorberende behuizing zorgen voor een zeer laag vibratieniveau.



CE002GZ01

## CE002G

- Versie zonder wateraansluiting, ontworpen voor droog zagen
- Met AWS & stofzuigaansluiting
- Incl. diamantschijf



CE001GZ

Promo: gratis  
diamantschijf  
355 mm E-12996  
bij CE001GZ



**NIEUW**

	CE001GZ	CE002GZ01
Spanning	72 V (80Vmax)	72 V (80Vmax)
Bijgeleverde accu's/lader	-	-
Ø zaagblad	355 mm	355 mm
Toerental onbelast	5300 min <sup>-1</sup>	4200 min <sup>-1</sup>
Max. zaagdiepte	127 mm	127 mm
Trillingsniveau (ah) vooraan / achteraan	2,5 m/s <sup>2</sup> / 1,8 m/s <sup>2</sup>	2,5 m/s <sup>2</sup> / 1,8 m/s <sup>2</sup>
AWS	-	✓
Gewicht	12,3 - 14,1 kg	13,1 - 15,1 kg
Prijs in €	excl. btw	€ 1.099,00
	incl. btw	€ 1.329,79
		€ 1.219,00
		€ 1.474,99



Compacte afmetingen en kleine omtrek van de handgreep



GA038GM201



	GA035GZ	GA036GZ	GA037GZ01	GA037GM201	GA037GT201	GA038GZ01	GA038GM201	GA038GT201
Spanning	36 V (40Vmax)	36 V (40Vmax)	36 V (40Vmax)	36 V (40Vmax)	36 V (40Vmax)	36 V (40Vmax)	36 V (40Vmax)	36 V (40Vmax)
Bijgeleverde accu's	-	-	-	2 x BL4040	2 x BL4050F	-	2 x BL4040	2 x BL4050F
Bijgeleverde lader	-	-	-	DC40RA	DC40RA	-	DC40RA	DC40RA
Schijfdiameter	150 mm	150 mm	180 mm	180 mm	180 mm	230 mm	230 mm	230 mm
Toerental onbelast	8500 min <sup>-1</sup>	8500 min <sup>-1</sup>	7800 min <sup>-1</sup>	7800 min <sup>-1</sup>	7800 min <sup>-1</sup>	6600 min <sup>-1</sup>	6600 min <sup>-1</sup>	6600 min <sup>-1</sup>
Slijpdiepte	46 mm	46 mm	68 mm	68 mm	68 mm	73 mm	73 mm	73 mm
Type schakelaar	Schuifschakelaar met vergrendeling	Lepelschakelaar zonder vergrendeling	Lepelschakelaar zonder vergrendeling	Lepelschakelaar zonder vergrendeling	Lepelschakelaar zonder vergrendeling	Lepelschakelaar zonder vergrendeling	Lepelschakelaar zonder vergrendeling	Lepelschakelaar zonder vergrendeling
AWS	-	-	✓ excl. Bluetooth unit	✓ excl. Bluetooth unit	✓ excl. Bluetooth unit	✓ excl. Bluetooth unit	✓ excl. Bluetooth unit	✓ excl. Bluetooth unit
Verpakking	-	-	Koffer	Koffer	Koffer	Koffer	Koffer	Koffer
Gewicht	3,0 - 3,7 kg	3,0 - 3,7 kg	4,4 - 5,4 kg	4,4 - 5,4 kg	4,4 - 5,4 kg	4,6 - 7,4 kg	4,6 - 7,4 kg	4,6 - 7,4 kg
Prijs in €	excl. btw	€ 219,00	€ 315,00	€ 779,00	€ 845,00	€ 315,00	€ 779,00	€ 835,00
	incl. btw	€ 264,99	€ 381,15	€ 942,59	€ 1.022,45	€ 381,15	€ 942,59	€ 1.010,35
		€ 229,00	€ 315,00	€ 779,00	€ 845,00	€ 315,00	€ 779,00	€ 835,00
		€ 277,09	€ 381,15	€ 942,59	€ 1.022,45	€ 381,15	€ 942,59	€ 1.010,35

# NEXT GENERATION TECHNOLOGY

## ACCU METAALCIRKELZAAG 185 MM



CS002GZ

- Grote snijcapaciteit dankzij de compacte tandwieloverbrenging
- Compartiment in aluminium voor het opvangen van metaalsnippers
- De AFT functie schakelt de motor onmiddellijk uit wanneer het zaagblad blokkeert

		CS002GZ
Spanning		36 V (40Vmax)
Bijgeleverde accu's/lader		-
Ø zaagblad		185 mm
Toerental onbelast		3500 min <sup>-1</sup>
Max. zaagdiepte		67 mm
Trillingsniveau (ah)		2,5 m/s <sup>2</sup>
Gewicht		4,2 - 5,4 kg
Prijs in €	excl. btw	€ 509,00
	incl. btw	€ 615,89

## ACCU MENGER



- Zeer krachtig, ook geschikt voor het mengen van zwaardere materialen
- Mechanische overbrenging met 2 snelheden
- Duimwieletje voor het instellen van het maximaal toerental, variabel toerental regeling, aan-vergrendelknop en uit-vergrendelknop, softstart
- Inschroefbare ashouder met adapter M12 + M14 binnendraad
- Uitstekende bescherming van schakelaar en accu



**Optioneel accessoire:**  
beschermkap "L" voor BL4050F en BL4080F (1911R6-2)

		UT001GZ02
Spanning		36V (40Vmax)
Bijgeleverde accu's		-
Bijgeleverde lader		-
Toerental onbelast		0- 500min <sup>-1</sup> 0- 920min <sup>-1</sup>
Aansluiting		1/2" - 20 UNF Male Adapter M12 & M14
Gewicht		5,7-7,0 kg
Prijs in €	excl. btw	€ 549,00
	incl. btw	€ 664,29

## ACCU BETONTRILNAALDEN



VR001GZ



VR003G

## ACCESSOIRES

Artikel	Diameter	Lengte	Prijs excl. btw	Prijs incl. btw
1910E1-5	32 mm	1,2 m	€ 299,00	€ 361,79
1910E2-3	32 mm	1,7 m	€ 329,00	€ 398,09
1910C2-9	32 mm	2,4 m	€ 359,00	€ 434,39
1910E3-1	38 mm	1,2 m	€ 329,00	€ 398,09
1910C4-5	38 mm	2,4 m	€ 379,00	€ 458,59



	VR001GZ	VR003GZ	VR003GM101	VR004GZ	VR004GM101
Spanning	36 v (40Vmax)	36 v (40Vmax)	36 v (40Vmax)	36 v (40Vmax)	36 v (40Vmax)
Bijgeleverde accu's	-	-	1x BL4040	-	1x BL4040
Bijgeleverde lader	-	-	DC40RA	-	DC40RA
Ø trilflæs	-(enkel motor)	32 mm	32 mm	38 mm	38 mm
Lengte naald	-(enkel motor)	1,2 m	1,2 m	1,2 m	1,2 m
Trillingsfrequentie	12000-15000 min <sup>-1</sup>	12000-15000 min <sup>-1</sup>	12000-15000 min <sup>-1</sup>	12000-15000 min <sup>-1</sup>	12000-15000 min <sup>-1</sup>
Gewicht	4,8 - 7,8 kg	4,8 - 7,8 kg	4,8 - 7,8 kg	4,8 - 7,8 kg	4,8 - 7,8 kg
Prijs in €	excl. btw	€ 259,00	€ 549,00	€ 829,00	€ 565,00
	incl. btw	€ 313,39	€ 664,29	€ 1.003,09	€ 683,65



JR002GM201



**JR002G**



JR001GD201



**Gedempte ophanging**

De accu en de behuizing zijn verbonden met trillingsabsorberende rubbers.

- Vermogen vergelijkbaar met model op netstroom
- Met pendelmechanisme (JR002G)
- Zeer laag trillingsniveau dankzij AVT technologie
- Handige bladontgrendelingshendel en verstelbare aanslag
- Ledverlichting

**Gereedschapsloze aanpassing van de aanslag**

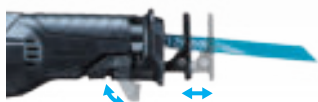

	JR001GZ	JR001GD201	JR001GM201	JR002GZ	JR002GM201	
Spanning	36 V (40Vmax)	36 V (40Vmax)	36 V (40Vmax)	36 V (40Vmax)	36 V (40Vmax)	
Bijgeleverde accu's	0	2 x BL4025	2 x BL4040	-	2 x BL4040	
Bijgeleverde lader	-	DC40RA	DC40RA	-	DC40RA	
Slaglengte	32 mm	32 mm	32 mm	32 mm	32 mm	
Aantal zaagbewegingen	0 - 2300 min <sup>-1</sup> 0 - 3000 min <sup>-1</sup>	0 - 2300 min <sup>-1</sup> 0 - 3000 min <sup>-1</sup>	0 - 2300 min <sup>-1</sup> 0 - 3000 min <sup>-1</sup>	0 - 3000 min <sup>-1</sup> 0 - 3000 min <sup>-1</sup>	0 - 3000 min <sup>-1</sup> 0 - 3000 min <sup>-1</sup>	
Pendelinstelling	-	-	-	✓	✓	
AVT	-	-	-	✓	✓	
Gewicht	4,2 - 4,5 kg	4,2 - 4,5 kg	4,2 - 4,5 kg	4,6 - 5,8 kg	4,6 - 5,8 kg	
Prijs in €	excl. btw	€ 275,00	€ 655,00	€ 755,00	€ 329,00	€ 815,00
	incl. btw	€ 332,75	€ 792,55	€ 913,55	€ 398,09	€ 986,15



PB002GM201

- Grote zaagcapaciteit tot Ø127 mm
- Variabele snelheidsregeling
- Hoge bandsnelheid
- Gemakkelijke spoorverstelling

	PB002GZ	PB002GM201	
Spanning	36 V (40Vmax)	36 V (40Vmax)	
Bijgeleverde accu's	-	2x BL4040	
Bijgeleverde lader	-	DC40RA	
Zaagcapaciteit	127 x 127 mm	127 x 127 mm	
Zaaglint	1140 x 13 x 0,5 mm	1140 x 13 x 0,5 mm	
Gewicht	6,6 - 7,8 kg	6,6 - 7,8 kg	
Prijs in €	excl. btw	€ 549,00	€ 1.019,00
	incl. btw	€ 664,29	€ 1.232,99



PV001GM101

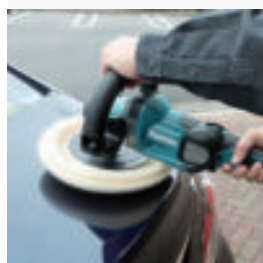

	PV001GZ	PV001GM101	
Spanning	36 V (40Vmax)	36 V (40Vmax)	
Bijgeleverde accu's	-	1x BL4040	
Bijgeleverde lader	-	DC40RA	
Diameter	180 mm	180 mm	
Toerental onbelast	0 - 2200 min <sup>-1</sup>	0 - 2200 min <sup>-1</sup>	
Gewicht	3,2 - 3,9 kg	3,2 - 3,9 kg	
Prijs in €	excl. btw	€ 349,00	€ 639,00
	incl. btw	€ 422,29	€ 773,19

# NEXT GENERATION TECHNOLOGY

## ACCU BOVEN- EN KANTENFREES



- Compact en flexibel systeem
- Zeer hoog vermogen dankzij 40Vmax technologie
- Zachte rem
- Verschillende hulpstukken meegeleverd

RT001GM208

		RT001GZ16	RT001GM208
Spanning		36 V (40Vmax)	36 V (40Vmax)
Bijgeleverde accu's		-	2x BL4040
Bijgeleverde lader		-	DC40RA
Toerental onbelast		10000-31000 min <sup>-1</sup>	10000-31000 min <sup>-1</sup>
Max. induikdiepte		40 mm	40 mm
Ø spantang - bereik		6 - 8 mm	6 - 8 mm
Ø spantang - inbegrepen		6 mm, 8 mm	6 mm, 8 mm
AWS		✓ excl. Bluetooth unit	✓ excl. Bluetooth unit
Gewicht		2,2 - 2,5 kg	2,2 - 2,5 kg
Prijs in €	excl. btw	€ 439,00	€ 899,00
	incl. btw	€ 531,19	€ 1.087,79

## ACCU SCHAAF



- Even krachtig als een machine op netstroom
- Kan tot 4,0 mm in één passage schaven
- Spaanders kunnen links of rechts uitgeworpen worden
- Zool met 3 groeven voor het afschuiven van kanten
- Sponningsdiepte tot 25 mm



KP001GM202

		KP001GZ01	KP001GM202
Spanning		36 V (40Vmax)	36 V (40Vmax)
Bijgeleverde accu's		-	2x BL4040
Bijgeleverde lader		-	DC40RA
Toerental onbelast		15000 min <sup>-1</sup>	15000 min <sup>-1</sup>
Schaafbreedte		82 mm	82 mm
Max. spaanafname		40mm	40mm
AWS		✓	✓
Gewicht		3,7 - 4,9 kg	3,7 - 4,9 kg
Prijs in €	excl. btw	€ 349,00	€ 815,00
	incl. btw	€ 422,29	€ 986,15

## ACCU INVALCIRKELZAAG



SP001GZ03



**AWS compatibel**  
Voor het draadloos aansturen van een AWS compatibele stofzuiger.  
(incl. Bluetooth unit)

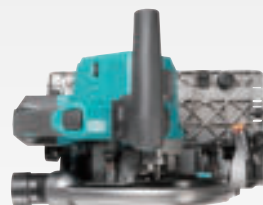

**Compact en licht, perfect uitgebalanceerd.**  
Door het gebruik van slechts één 40Vmax accu en magnesium componenten.



**Grote zaagcapaciteit**  
Zaagdiepte van 56 mm bij 90° en een kantelbereik van -1 tot 48°.



**Perfekte geleiding**  
De magnesium zool past rechtstreeks op een geleiderail.

		SP001GZ03
Spanning		36 V (40Vmax)
Bijgeleverde accu's		-
Ø zaagblad		165 mm
Toerental onbelast		2500 - 4900 min <sup>-1</sup>
Zaagdiepte (90°)		56 mm
AWS		✓
Gewicht		4,4 - 5,0 kg
Prijs in €	excl. btw	€ 465,00
	incl. btw	€ 562,65

## ACCU DECOUPEERZAGEN

**BL**  
MOTOR

**XGT**  
**40V**  
Lithium  
max

### JV001G

- Uitstekende prestaties dankzij 40Vmax technologie
- Lengte slechts 283 mm
- Bredere voet voor meer stabiliteit



JV001GZ01

**NIEUW**

**NIEUW**

		JV001GZ01	JV001GM201
Spanning		36 V (40Vmax)	36 V (40Vmax)
Bijgeleverde accu's		-	2x BL4040
Bijgeleverde lader		-	DC40RA
Aantal zaagbewegingen		800 - 3500 min <sup>-1</sup>	800 - 3500 min <sup>-1</sup>
Max. capaciteit hout		135 mm	135 mm
Slaglengte		26 mm	26 mm
Gewicht		2,6 - 2,9 kg	2,6 - 2,9 kg
Verpakking		Makpac	Makpac
Prijs in €	excl. btw	€ 299,00	€ 759,00
	incl. btw	€ 361,79	€ 918,39

## ACCU CIRKELZAGEN

**BL**  
MOTOR

**AWS**  
Auto-start Wireless System

**XGT**  
**40V**  
Lithium  
max

### HS012G

- Bijzonder krachtige accucirkelzaag met links geplaatst zaagblad.
- Compact, licht en perfect uitgebalanceerd dankzij de nieuw ontwikkelde BL motor.
- Diepteregeling met duidelijk afleesbare schaal en kantelbaar tot 45°.
- De zool en beschermkap zijn uitgevoerd in hoogwaardig magnesium.
- Opgelet deze machine past niet rechtstreeks op een geleiderail.



HS012GZ01



HS003GM201



HS011GT201



HS009GT201

		HS012GZ01	HS003GZ	HS003GM201	HS004GZ	HS004GZ01	HS004GM202	HS009GZ	HS009GT201	HS010GZ	HS010GT201	HS011GZ	HS011GT201
Spanning		36 V (40Vmax)	36 V (40Vmax)	36 V (40Vmax)	36 V (40Vmax)	36 V (40Vmax)	36 V (40Vmax)	36 V (40Vmax)	36 V (40Vmax)	36 V (40Vmax)	36 V (40Vmax)	36 V (40Vmax)	36 V (40Vmax)
Bijgeleverde accu's		-	-	2 x BL4040	-	-	2 x BL4040	-	2x BL4050F	-	2x BL4050F	-	2x BL4050F
Bijgeleverde lader		-	-	DC40RA	-	-	DC40RA	-	DC40RA	-	DC40RA	-	DC40RA
Ø zaagblad		165 mm	190 mm	190 mm	190 mm	190 mm	190 mm	235 mm	235 mm	235 mm	235 mm	270 mm	270 mm
Zaagdiepte (90°)		57 mm	68,5 mm	68,5 mm	62,5 mm	62,5 mm	62,5 mm	85 mm	85 mm	85 mm	85 mm	101 mm	101 mm
Rechtstreeks op geleiderail		-	-	-	✓	✓	✓	✓	✓	-	-	✓	✓
AWS		✓	✓	✓	✓	✓	✓	✓	✓	✓	✓	✓	✓
		excl. Bluetooth unit	excl. Bluetooth unit	excl. Bluetooth unit	excl. Bluetooth unit	✓	✓	excl. Bluetooth unit	excl. Bluetooth unit	excl. Bluetooth unit	excl. Bluetooth unit	excl. Bluetooth unit	excl. Bluetooth unit
Verpakking		Makpac	-	Makpac	-	-	Makpac	-	Koffer	-	Koffer	-	-
Gewicht		3,2 - 4,4kg	4,1 - 4,4 kg	4,1 - 4,4 kg	4,4 - 4,7 kg	4,4 - 4,7 kg	4,4 - 4,7 kg	5,1 - 5,7 kg	5,1 - 5,7 kg	6,0 - 6,4 kg	6,0 - 6,4 kg	5,5 - 6,7 kg	5,5 - 6,7 kg
Prijs in €	excl. btw	€ 349,00	€ 409,00	€ 889,00	€ 459,00	€ 489,00	€ 949,00	€ 475,00	€ 1.029,00	€ 439,00	€ 989,00	€ 525,00	€ 1.075,00
	incl. btw	€ 422,29	€ 494,89	€ 1.075,69	€ 555,39	€ 591,69	€ 1.148,29	€ 574,75	€ 1.245,09	€ 531,19	€ 1.196,69	€ 635,25	€ 1.300,75



# NEXT GENERATION TECHNOLOGY

## ACCU CIRKELZAGEN MET ACHTERHANDGREEP



RS001GM101



RS002GT101

### RS001G / RS002G

- Speciaal ontwerp met handgreep achteraan
- Krachtig en licht (magnesium zool)



	RS001GZ	RS001GM101	RS002GZ	RS002GT101
Spanning	36 V (40Vmax)	36 V (40Vmax)	36 V (40Vmax)	36 V (40Vmax)
Bijgeleverde accu's	0	1 x BL4040	0	1 x BL4050F
Zaagdiepte (90°)	65 mm	65 mm	95 mm	95 mm
Ø zaagblad	185 mm	185 mm	260 mm	260 mm
AWS	-	-	✓ excl. Bluetooth unit	✓ excl. Bluetooth unit
Toerental onbelast	6400 min <sup>-1</sup>	6400 min <sup>-1</sup>	4000 min <sup>-1</sup>	4000 min <sup>-1</sup>
Gewicht	5,0 - 5,6 kg	5,0 - 5,6 kg	5,7 - 6,3 kg	5,7 - 6,3 kg
Prijs in €	excl. btw	€ 315,00	€ 599,00	€ 465,00
	incl. btw	€ 381,15	€ 724,79	€ 562,65

## ACCU TELESCOPISCHE AFKORT - VERSTEKZAGEN



Belangrijke bedieningsknoppen zijn vooraan geplaatst

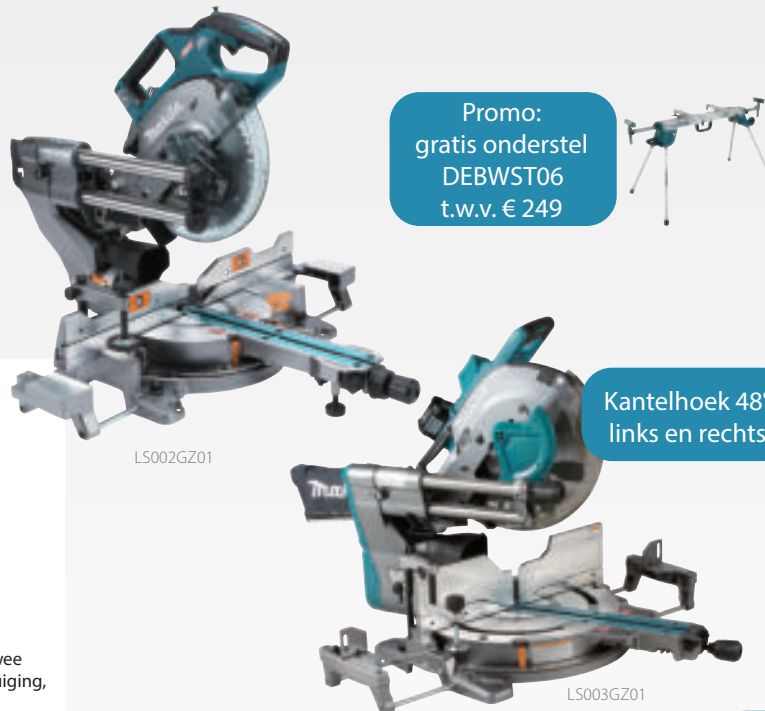

LS002GZ01

Promo:  
gratis onderstel  
DEBWS06  
t.w.v. € 249



Uitschuifbare zijsteunen



### Efficiënte stofafzuiging

De geoptimaliseerde stofafzuiging met twee poorten garandeert een perfecte stofafzuiging, ook bij het zagen van dunne planken.

Kantelhoek 48°  
links en rechts

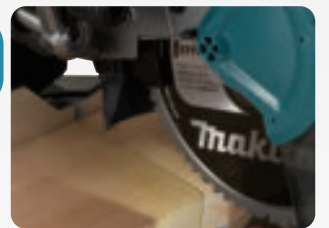

### Aanduiding van de zaaglijn

Een led lamp werpt de schaduw van het zaagblad op het werkstuk, deze aanduiding is onder alle omstandigheden exact.

	LS002GZ01	LS004GZ01	LS003GZ01
Spanning	36 V (40Vmax)	36 V (40Vmax)	36 V (40Vmax)
Bijgeleverde accu's	0	0	0
Ø zaagblad	216 mm	260 mm	305 mm
Verstekhoek	60 L / 60 R	60° L / 60° R	60 L / 60 R
Kantelhoek	48° L / 48° R	48° L / 48° R	48° L / 48° R
Toerental onbelast	4800 min <sup>-1</sup>	3600 min <sup>-1</sup>	3600 min <sup>-1</sup>
Capaciteit	70 x 312 mm	91 x 312 mm	107 x 312 mm
AWS	✓	✓	✓
DXT	✓	✓	✓
Gewicht	16,4 - 17,0 kg	26,6 - 27,2 kg	30,5 - 31,1 kg
Prijs in €	excl. btw	€ 719,00	€ 819,00
	incl. btw	€ 869,99	€ 990,99

# DXT

Deep and Exact Cutting Technology

De gepatenteerde constructie met drieduidige tandwieloverbrenging en uitsparing achter de flens laat toe om een groter deel van het zaagblad te benutten. Daardoor kunnen ook hoge plinten verticaal of in verstek afgekort worden.



### Manuele bediening

De afzuiging kan via een schakelaar ook manueel gestart worden (via Bluetooth), dit is ook handig om de machine schoon te maken.

COMBOPACK XGT

XGT  
40V  
L-ion  
max



Promo: gratis  
extra accu 2,5 Ah

DK0114G201

Bijgeleverde accu's	2 x BL4040
Bijgeleverde lader	DC40RA
Laadadapter	ADP10
Klopboor- en schroef- machine	HP001G
Slagschroevendraaier	TD001G
Verpakking	Gereedschapstas
Prijs in €	excl. btw € 919,00 incl. btw € 1.111,99

COMBOPACK XGT

XGT  
40V  
L-ion  
max



Promo: gratis  
extra accu 2,5 Ah

DK0124G201

Bijgeleverde accu's	2 x BL4040
Bijgeleverde lader	DC40RA
Boor- en schroefmachine	DF001G
Haakse slijper 125 mm	GA005G
Verpakking	Makpac
Prijs in €	excl. btw € 839,00 incl. btw € 1.015,19

COMBOPACK XGT

XGT  
40V  
L-ion  
max



Promo: gratis  
extra accu 4,0 Ah

DK0125G301

Bijgeleverde accu's	2 x BL4040
Bijgeleverde lader	DC40RA
Boor- en schroefmachine	DF001G
Slagschroevendraaier	TD001G
Haakse slijper 125 mm	GA005G
Verpakking	Makpac
Prijs in €	excl. btw € 1.099,00 incl. btw € 1.329,99

# NEXT GENERATION TECHNOLOGY

COMBOPACK XGT

XGT  
40V Li-ion max

Promo: gratis extra  
accu 4,0 Ah + extra  
lader DC40RA



DK0126G401

Bijgeleverde accu's	2 x BL4040	
Bijgeleverde lader	DC40RA	
Haakse slijper 125 mm	GA005G	
Reciprozaag	JR001G	
Boor- en schroefmachine	DF001G	
Slagschroevendraaier	TD001G	
Verpakking	Gereedschapstas	
Prijs in €	excl. btw	€ 1.309,00
	incl. btw	€ 1.583,89

COMBOPACK XGT

XGT  
40V Li-ion max



Promo: gratis  
Powerpack 4,0 Ah  
t.w.v. € 549

DK0128G601

Bijgeleverde accu's	2 x BL4040	
Bijgeleverde lader	DC40RA	
Boor- en schroefmachine	DF001G	
Slagschroevendraaier	TD001G	
Haakse slijper 125 mm	GA005G	
Reciprozaag	JR001G	
SDS plus combihamer	HR002G	
Cirkelzaag 190 mm	HS003G	
Verpakking	Gereedschapstas	
Prijs in €	excl. btw	€ 2.219,00
	incl. btw	€ 2.684,99

# HET XGT-PLATFORM



## AS001GZ

Blaas- en zuig-  
machine 40Vmax  
Prijs excl. BTW  
**€ 169,00**  
Prijs incl. BTW  
**€ 204,49**



## CF002GZ

Ventilator 40Vmax  
Prijs excl. BTW  
**€ 199,00**  
Prijs incl. BTW  
**€ 240,79**



## CL001GZ05

Staalstofzuiger  
40Vmax  
Prijs excl. BTW  
**€ 165,00**  
Prijs incl. BTW  
**€ 199,65**



## CL002GZ03

Staalstofzuiger  
40Vmax  
Prijs excl. BTW  
**€ 159,00**  
Prijs incl. BTW  
**€ 192,39**



## CL002GZ07

Staalstofzuiger  
40Vmax  
Prijs excl. BTW  
**€ 159,00**  
Prijs incl. BTW  
**€ 192,39**



## CL003GZ04

Staalstofzuiger  
40Vmax  
Prijs excl. BTW  
**€ 179,00**  
Prijs incl. BTW  
**€ 216,59**



## CS002GZ

Metaalcirkel-  
zaag 40Vmax  
Prijs excl. BTW  
**€ 509,00**  
Prijs incl. BTW  
**€ 615,89**



## DA001GZ01

Haakse boor-  
machine 40Vmax  
Prijs excl. BTW  
**€ 545,00**  
Prijs incl. BTW  
**€ 659,45**



## DF001GZ01

Boor- en schroef-  
machine 40Vmax  
Prijs excl. BTW  
**€ 275,00**  
Prijs incl. BTW  
**€ 332,75**



## DF002GZ01

Boor- en schroef-  
machine 40Vmax  
Prijs excl. BTW  
**€ 175,00**  
Prijs incl. BTW  
**€ 211,75**



## FN001GZ02

Minibradpistool  
40Vmax  
Prijs excl. BTW  
**€ 445,00**  
Prijs incl. BTW  
**€ 538,45**



## GA013GZ01

Haakse slijper  
125 mm 40Vmax  
Prijs excl. BTW  
**€ 255,00**  
Prijs incl. BTW  
**€ 308,55**



## GA029GZ

Haakse slijper  
125 mm 40Vmax  
Prijs excl. BTW  
**€ 255,00**  
Prijs incl. BTW  
**€ 308,55**



## GA038GZ01

Haakse slijper  
230 mm 40Vmax:  
Prijs excl. BTW  
**€ 315,00**  
Prijs incl. BTW  
**€ 381,15**



## GA041GZ

X-Lock haakse slijper  
125 mm 40Vmax  
Prijs excl. BTW  
**€ 299,00**  
Prijs incl. BTW  
**€ 361,79**



## GA044GZ

X-Lock haakse slijper  
125 mm 40Vmax  
Prijs excl. BTW  
**€ 309,00**  
Prijs incl. BTW  
**€ 373,89**



## HP001GZ01

Klopboor- en schroef-  
machine 40Vmax  
Prijs excl. BTW  
**€ 285,00**  
Prijs incl. BTW  
**€ 344,85**



## HP002GZ01

Klopboor- en schroef-  
machine 40Vmax  
Prijs excl. BTW  
**€ 185,00**  
Prijs incl. BTW  
**€ 223,85**



## HR002GZ02

SDS-PLUS Combihamer  
40Vmax  
Prijs excl. BTW  
**€ 479,00**  
Prijs incl. BTW  
**€ 579,59**



## HR005GZ01

SDS-Max Combihamer  
40Vmax  
Prijs excl. BTW  
**€ 845,00**  
Prijs incl. BTW  
**€ 1.022,45**



## HR006GZ

SDS-Max Combihamer  
40Vmax  
Prijs excl. BTW  
**€ 1.079,00**  
Prijs incl. BTW  
**€ 1.305,59**



## HR007GZ01

SDS-PLUS Combihamer  
40Vmax  
Prijs excl. BTW  
**€ 359,00**  
Prijs incl. BTW  
**€ 434,39**



## HR009GZ02

SDS-PLUS Combihamer  
40Vmax  
Prijs excl. BTW  
**€ 649,00**  
Prijs incl. BTW  
**€ 785,29**



## HS004GZ

Cirkelzaag 190 mm  
40Vmax  
Prijs excl. BTW  
**€ 459,00**  
Prijs incl. BTW  
**€ 555,39**



## HS009GZ

Cirkelzaag 190 mm  
40Vmax  
Prijs excl. BTW  
**€ 475,00**  
Prijs incl. BTW  
**€ 574,75**



## HS010GZ

Cirkelzaag  
235 mm 40Vmax  
Prijs excl. BTW  
**€ 439,00**  
Prijs incl. BTW  
**€ 531,19**



## HS011GZ

Cirkelzaag 270 mm  
40Vmax  
Prijs excl. BTW  
**€ 525,00**  
Prijs incl. BTW  
**€ 635,25**



## HS012GZ01

Cirkelzaag 165 mm  
40Vmax  
Prijs excl. BTW  
**€ 349,00**  
Prijs incl. BTW  
**€ 422,29**



## JR001GZ

Reciprozaag 40Vmax  
Prijs excl. BTW  
**€ 275,00**  
Prijs incl. BTW  
**€ 332,75**



## JR002GZ

Reciprozaag 40Vmax  
Prijs excl. BTW  
**€ 329,00**  
Prijs incl. BTW  
**€ 398,09**



## KP001GZ01

Schaaf 40Vmax  
Prijs excl. BTW  
**€ 349,00**  
Prijs incl. BTW  
**€ 422,29**



## KT001GZ

Waterkoker 40Vmax  
Prijs excl. BTW  
**€ 255,00**  
Prijs incl. BTW  
**€ 308,55**



## MP001GZ

Lucht pomp  
40Vmax  
Prijs excl. BTW  
**€ 159,00**  
Prijs incl. BTW  
**€ 192,39**



## PB002GZ

Bandzaag 40Vmax  
Prijs excl. BTW  
**€ 549,00**  
Prijs incl. BTW  
**€ 664,29**

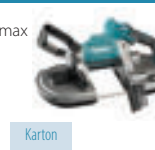

## PT001GZ01

Pinpistool  
40Vmax  
Prijs excl. BTW  
**€ 445,00**  
Prijs incl. BTW  
**€ 538,45**



## PV001GZ

Polijstmachine  
40Vmax  
Prijs excl. BTW  
**€ 349,00**  
Prijs incl. BTW  
**€ 422,29**



## RS001GZ

Wormzaag 185 mm  
40Vmax  
Prijs excl. BTW  
**€ 315,00**  
Prijs incl. BTW  
**€ 381,15**



## RS002GZ

Wormzaag 260 mm  
40Vmax  
Prijs excl. BTW  
**€ 465,00**  
Prijs incl. BTW  
**€ 562,65**



## RT001GZ16

Boven- en kan-  
tenfrees 40Vmax  
Prijs excl. BTW  
**€ 439,00**  
Prijs incl. BTW  
**€ 531,19**



## SP001GZ03

Invalcirkelzaag  
40Vmax  
Prijs excl. BTW  
**€ 465,00**  
Prijs incl. BTW  
**€ 562,65**



## TD003GZ01

Slagschroevendraaier  
40Vmax  
Prijs excl. BTW  
**€ 199,00**  
Prijs incl. BTW  
**€ 240,79**



## TW001GZ01

Slagmoersleutel  
40Vmax  
Prijs excl. BTW  
**€ 379,00**  
Prijs incl. BTW  
**€ 458,59**



## TW004GZ

Slagmoersleutel  
40Vmax  
Prijs excl. BTW  
**€ 255,00**  
Prijs incl. BTW  
**€ 308,55**



## TW007GZ01

Slagmoersleutel  
40Vmax  
Prijs excl. BTW  
**€ 339,00**  
Prijs incl. BTW  
**€ 410,19**



## UT001GZ02

Menger 40Vmax  
Prijs excl. BTW  
**€ 549,00**  
Prijs incl. BTW  
**€ 664,29**



## VC002GLZ01

Stofzuiger 40Vmax  
Prijs excl. BTW  
**€ 599,00**  
Prijs incl. BTW  
**€ 724,79**



## VC003GLZ

Stofzuiger 40Vmax  
Prijs excl. BTW  
**€ 489,00**  
Prijs incl. BTW  
**€ 591,69**



## VC005GLZ

Stofzuiger 40Vmax  
Prijs excl. BTW  
**€ 499,00**  
Prijs incl. BTW  
**€ 603,79**



## VR003GZ

Betontrilnaald  
40Vmax  
Prijs excl. BTW  
**€ 549,00**  
Prijs incl. BTW  
**€ 664,29**

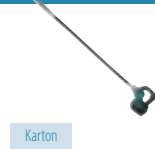

## VR004GZ

Betontrilnaald  
40Vmax  
Prijs excl. BTW  
**€ 565,00**  
Prijs incl. BTW  
**€ 683,65**

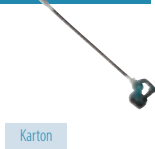

Prijzen geldig t.e.m. 31/12/2023

1. CHOOSE YOUR BODY!

2. CHOOSE YOUR POWER!

3. MIX IT UP!



191L29-0

Li-ion accu BL4020  
40Vmax • 2,0 Ah • 0,69 kg • 22 min\*



€ 129,00 excl. btw  
€ 156,09 incl. btw

191B36-3

Li-ion accu BL4025  
40Vmax • 2,5 Ah • 0,71 kg • 28 min\*



€ 149,00 excl. btw  
€ 180,29 incl. btw

191B26-6

Li-ion accu BL4040  
40Vmax • 4,0 Ah • 1,0 kg • 45 min\*



€ 215,00 excl. btw  
€ 260,15 incl. btw

1910N6-8

Li-ion accu BL4040F  
40Vmax • 4,0 Ah • 1,0 kg • 45 min\*



€ 245,00 excl. btw  
€ 296,45 incl. btw

191L47-8

Li-ion accu BL4050F  
40Vmax • 5,0 Ah • 1,3 kg • 50 min\*



€ 239,00 excl. btw  
€ 289,19 incl. btw

191X65-8

Li-ion accu BL4080F  
40Vmax • 8,0 Ah • 2,0 kg • 80 min\*



€ 349,00 excl. btw  
€ 422,29 incl. btw

191J81-6

XGT Powerpack 2,5 Ah



€ 439,00 excl. btw  
€ 531,19 incl. btw

191J65-4

XGT Powerpack 4,0 Ah



€ 329,00 excl. btw  
€ 398,09 incl. btw

191J97-1

XGT Powerpack 4,0 Ah



€ 549,00 excl. btw  
€ 664,29 incl. btw

191V35-5

XGT Powerpack 5,0 Ah



€ 619,00 excl. btw  
€ 748,99 incl. btw

191U00-8

XGT Powerpack 4,0 Ah



€ 625,00 excl. btw  
€ 756,25 incl. btw

191U28-6

XGT Powerpack 4,0 Ah



€ 999,00 excl. btw  
€ 1.208,79 incl. btw

191U13-9

XGT Powerpack 5,0 Ah



€ 699,00 excl. btw  
€ 845,79 incl. btw

191U42-2

XGT Powerpack 5,0 Ah



€ 1.179,00 excl. btw  
€ 1.426,59 incl. btw

191Y97-1

XGT Powerpack 8,0 Ah



€ 879,00 excl. btw  
€ 1.063,59 incl. btw

DEAADP001G

ADP001 Laadadapter  
USB-adapter voor XGT 40Vmax accu's



€ 50,80 excl. btw  
€ 61,47 incl. btw

\* Laadtijd met DC40RA

191E07-8

Oplader DC40RA

Snellader voor XGT 40Vmax accu's



€ 139,00 excl. btw  
€ 168,19 incl. btw

191N09-8

Duo snellader DC40RB

Duo snellader voor het gelijktijdig laden van twee XGT 40Vmax accu's



€ 225,00 excl. btw  
€ 272,25 incl. btw

191C10-7

ADP10 Laadadapter

Adapter om LXT 14,4 V en 18 V accu's te laden op een XGT 40Vmax lader



€ 59,50 excl. btw  
€ 72,00 incl. btw

1911L9-4

Duo oplader DC40WA

Traaglader voor XGT 40Vmax accu's



**NIEUW** € 129,90 excl. btw  
€ 157,18 incl. btw

1910D9-2

Communicatieadapter ADP12

Adapter om XGT-machines te verbinden met smartphone, laptop,...

\* de adapter wordt enkel tussen machine en accu geplaatst tijdens controle / bij het maken van de gewenste instellingen



**NIEUW**

€ 149,00 excl. btw  
€ 180,29 incl. btw

- Diefstalbeveiliging instellen d.m.v. een pincode
- De werkingsduur van accu's instellen
- De gebruikshistoriek van de XGT-machines raadplegen

COMPRESSOR **BL MOTOR** XGT **40V<sup>Li-ion</sup>max**

- Compact en lichtgewicht ontwerp, ideaal voor binnentoepassingen zoals nieten en spijkeren
- Olivrijne pomp met hoog luchtdebiet
- Manometer voor zowel tank- als uitgangsdruk
- Laag geluidsniveau
- Stevig metalen frame beschermt de motor en vergemakkelijkt het transport



		AC001GZ
Spanning		36V (40Vmax)
Bijgeleverde accu's		-
Debiet		34 l/min @ 6,0 bar
Inschakeldruk		7,2 bar
Uitschakeldruk		9,4 bar
Uitgangsdruk		0 - 9,3 bar
Geluidsdrukkniveau		68 dB(A)
Tankinhoud		7,6 L
Gewicht		10,1 - 12,8 kg
Prijs in €	excl. btw	€ 449,00
	incl. btw	€ 543,29

LUCHTPOMP **BL MOTOR** XGT **40V<sup>Li-ion</sup>max**



- Door het hoge debiet kunnen grotere banden en bijvoorbeeld ook speelgoed voor op het water opgeblazen worden.
- Drie modi: hoog debiet, laag debiet en "ball" mode om op een veilige manier speelballen op te blazen.
- Functie voor het aflaten van lucht indien de druk te hoog is.

		MP001GZ
Spanning		36 V (40Vmax)
Bijgeleverde accu's		0
Debiet		12 - 24 l/min
Max. druk		11,1 bar
Gewicht		2,9 - 3,5 kg
Prijs in €	excl. btw	€ 159,00
	incl. btw	€ 192,39

BLAAS- EN ZUIGMACHINE **BL MOTOR** XGT **40V<sup>Li-ion</sup>max**

- 4 vermogenstanden en variabele snelheid
- Handig kliksysteem voor het verwisselen van mondstukken
- Kan ook lucht wegzuigen via een optioneel accessoire
- Standaard geleverd met 5 blaasmonden



**Toepassingen:**

- Schoonblazen (gereedschap, machines, computers).
- Reinigen van luchtfilters
- Uitblazen van ankerkragen
- Opblazen/aflaten van strandballen, bootjes enz.
- Leegzuigen van verpakkingen (compacteer maken)



• Standaard



• Optioneel



		AS001GZ
Spanning		36 V (40Vmax)
Bijgeleverde accu's		-
Bijgeleverde lader		-
Blaaskracht		2,8 N
Debiet		0 - 1,3 m <sup>3</sup> /min
Max. onderdruk		103 mbar
Gewicht		1,5 - 2,3 kg
Prijs in €	excl. btw	€ 169,00
	incl. btw	€ 204,49

ACCU VENTILATOREN **BL MOTOR** XGT **40V<sup>Li-ion</sup>max**

AC adapter inbegrepen



CF001GZ



CF002GZ



CF003GZ

**CF003G**

- Werkt op 40Vmax, 18V of netstroom (middels adapter)
- Extra grote schoepen zorgen voor een groot debiet en stille werking
- Traploze snelheidsregeling



CF003G

**NIEUW**

	CF001GZ	CF002GZ	CF003GZ
Spanning	36 V (40Vmax) XGT / AC (Incl. AC-adapter)	36 V (40Vmax) XGT / AC (Incl. AC-adapter)	36 V (40Vmax) XGT / 18 V LXT / AC (Incl. AC-adapter)
Diameter	235 mm	330 mm	450 mm
Debiet (stand 1-2-3)	5,2 / 6,5 / 8,2 m <sup>3</sup> /min	18 / 26 / 37 m <sup>3</sup> /min	38 - 120 m <sup>3</sup> /min
Luchtsnelheid	120 / 150 / 190 m/min	120 / 170 / 240 m/min	96 - 300 m/min
Gewicht	2,0 - 3,0 kg	4,5 - 5,1 kg	7,9 - 10,5 kg
Prijs in €	excl. btw	€ 139,00	€ 445,00
	incl. btw	€ 168,19	€ 538,45

MICROGOLFOVEN



- Ideaal om voeding op te warmen op plaatsen waar geen netstroom beschikbaar is.
- Werkt met één 40Vmax accu of twee in parallel.
- Compact, gemakkelijk te transporteren.
- Vermogenniveaus: 350W en 500W
- De verwarmingstijd kan ingesteld worden van 10 seconden tot 20 minuten.
- Met 2x BL4040 en op volle vermogen kunnen ongeveer 5 maaltijden of 8 koppen van 200 ml opgewarmd worden.

		MW001GZ
Spanning		36V (40Vmax)
Bijgeleverde accu's		-
Bijgeleverde lader		-
Inhoud		8 l
Binnenafmetingen		255 x 241 x 120 mm
Uitgangsvermogen		350 W / 500 W
Autonomie (2x BL4040)		350 W: 21 min 500 W: 15 min
Gewicht		9,5 - 12,7 kg
Prijs in €	excl. btw	€ 859,00
	incl. btw	€ 1039,39

WATERKOKER



- Voeding met één XGT accu of twee in parallel
- Dubbellaagse roestvrijstalen wand
- Met voedingsstandaard en groot handvat
- Uitgerust met morsbeveiliging

		KT001GZ
Spanning		36 V (40Vmax)
Inhoud		0,8 l
Kooktijd voor 0,8 l		ca. 8 min
Verwarmcapaciteit 100 °C		1,2 l met 2 x BL4025
Gewicht		2,8 - 5,9 kg
Prijs in €	excl. btw	€ 255,00
	incl. btw	€ 308,55

VRIES-/ KOELBOX MET VERWARMFUNCTIE



CW004G

- Capaciteit van 29 l
- Uiterst efficiënt en groot koelvermogen door het gebruik van een compressor
- De ruimte kan onderverdeeld worden in twee vakken met elk een eigen temperatuurinstelling, bijvoorbeeld een koel- en vriesvak. Standaard geleverd met binnenbakje en binnenmand
- Het deksel kan aan beide zijden geopend worden of volledig verwijderd voor het gemakkelijk reinigen
- Met beugel om te rollen op de wielen en ook voorzien van inklabare handvaten zijdelings om gemakkelijk te dragen



CW003GZ



CW002GZ01



CW004GZ



CW004GZ



Leverbaar vanaf januari 2024

NIEUW

	CW003GZ	CW001GZ01	CW004GZ	CW002GZ01
Voeding	36 V (40Vmax) XGT / 18 V LXT / AC / 12 V DC - 24 V DC	36 V (40Vmax) XGT / 18 V LXT / AC / 12 V DC - 24 V DC	36 V (40Vmax) XGT / 18 V LXT / AC / 12 V DC - 24 V DC	36 V (40Vmax) XGT / 18 V LXT / AC / 12 V DC - 24 V DC
Inhoud	7 l	20 l	29 l	50 l
Koelen	-18 / -15 / -10 / -5 / 0 / 5 / 10 °C	-18 / -15 / -10 / -5 / 0 / 5 / 10 °C	-18 / -15 / -10 / -5 / 0 / 5 / 10 °C	-18 / -15 / -10 / -5 / 0 / 5 / 10 °C
Verwarmen	30 / 35 / 40 / 45 / 50 / 55 / 60 °C	30 / 35 / 40 / 45 / 50 / 55 / 60 °C	30 / 35 / 40 / 45 / 50 / 55 / 60 °C	30 / 35 / 40 / 45 / 50 / 55 / 60 °C
Autonomie ca.	-18 °C: 5,5 uur, 5 °C: 13,5 uur, 60 °C: 5,5 uur (1x BL4040)	-18 °C: 8 uur, 5 °C: 22,5 uur, 60 °C: 7 uur (2x BL4040)	-18 °C: 10,0 h, 5 °C: 24,0 h (at 30 °C) 60 °C: 9,0 h (at 0 °C) Dual room mode (left -18 °C, right 5 °C): 9,0 h	-18 °C: 8 uur, 5 °C: 19,5 uur, 60 °C: 4,5 uur (2x BL4040)
Afmetingen	456 x 245 x 308 mm	663 x 341 x 372 mm	676 x 345 x 471 mm	867 x 465 x 476 mm
Gewicht	7,9 - 9,4 kg	13,8 - 17,3 kg	17,5 - 20,9 kg	25,6 - 29,0 kg
Prijs in €	excl. btw	€ 639,00	€ 839,00	€ 1.099,00
	incl. btw	€ 773,19	€ 869,99	€ 1.329,79



CW004GZ

# Het grootste 18 V Lithium-ion assortiment ter wereld.

Meer dan 380 machines met slechts één accu.

**18V**  
**LITHIUM-ION**

**3**  
JAAR  
**GARANTIE**  
OP MACHINES  
Na registratie op  
[www.makita.be](http://www.makita.be)

**LXT**

Lithium-Ion Extreme Technology

- + Performante Lithium-Ion accu's
- + Een unieke en snelle oplaadtechnologie
- + Energie-efficiënte koolborstelloze motoren
- + Meervoudige bescherming tegen overbelasting







2x 18V

18V

18V LITHIUM-ION

# LXT-Platform

Betrouwbaar – veelzijdig – krachtig

## Snel en optimaal laden

Wanneer de batterijen warm zijn, dan is het belangrijk dat die eerst gekoeld worden vooraleer het laadtraject te starten. De lader is uitgerust met een ventilator die de batterijen koelt vóór en tijdens het laden om de laadtijd te verkorten.

**Makita geavanceerd laadsysteem**  
Geforceerde koeling



Snelladen



**Standaard laadsysteem**  
Natuurlijke warmteafvoer



Langere laadtijd



**3.0Ah**  
**Li-ion**

**22 minuten**

**3,0 Ah**  
**BL1830B**

**SNELSTE LAADTIJD**

**4.0Ah**  
**Li-ion**

**36 minuten**

**4,0 Ah**  
**BL1840B**

**5.0Ah**  
**Li-ion**

**45 minuten**

**5,0 Ah**  
**BL1850B**

**6.0Ah**  
**Li-ion**

**55 minuten**

**6,0 Ah**  
**BL1860B**

**LANGSTE WERKDUUR**



## STROOMOMVORMER BAC01



### EUABAC01

€ 699,00 excl. btw  
€ 845,79 incl. btw



PDC niet inbegrepen

- Converteert de accuspanning naar een 230V/50 Hz wisselspanning voor het gebruik van machines op netstroom
- BAC01 is de omvormer, deze dient gevoed te worden met het accupack PDC1200 of PDC01
- Maximale continue belasting (met PDC1200): 1400 W (VA), piekbelasting 2800 W (VA)
- De hoogwaardige electronica produceert een zuivere sinusgolf waardoor ook gevoelige apparatuur mag aangesloten worden
- Verschillende uitgangen: 2x AC 230 V, 2x USB type A, 2x USB type C en 12V
- Duidelijke weergave van de actuele belasting
- Beveiligd tegen overbelasting

€ 699,00 excl. btw  
€ 845,79 incl. btw

**DRAAGBAAR ACCUPACK**

**PDC01**

**PDC1200**

**191A59-5**

PDC01 ZONDER BATTERIJEN



Inclusief adapter  
18V & 2 x 18V

€ 495,00 excl. btw  
€ 598,95 incl. btw

**191C50-5**

PDC01 MET 4 x BL1850B EN  
DUOSNELLADER DC18RD



PDC01 KAN TOT 4 LXT-  
BATTERIJEN DRAGEN

BL1850B

DC18RD

€ 825,00 excl. btw  
€ 998,25 incl. btw

**BEAPDC1200A01**

DRAAGBAAR ACCUPACK PDC1200  
MET GEÏNTEGREERDE BATTERIJCELLEN



ENERGIECAPACITEIT  
1206 Wh

Inclusief lader 191L00-4  
(DC4001) en adapter  
191J51-5 (2 x 18V)

€ 1299,00 excl. btw  
€ 1571,79 incl. btw

**197280-8**

accu BL1850B 18V 5,0 Ah



€ 119,00 excl. btw  
€ 143,99 incl. btw

**197288-2**

TWINPACK 18V 2 x 5,0 Ah



€ 219,00 excl. btw  
€ 264,99 incl. btw

**197422-4**

accu BL1860B 18V 6,0 Ah



€ 135,00 excl. btw  
€ 163,35 incl. btw

**DECADP05**

USB-adapter

USB-adapter voor 14,4V/18V accu's



€ 34,50 excl. btw  
€ 41,75 incl. btw

**197494-9**

POWERPACK 18V 2 x 4,0 Ah



€ 279,00 excl. btw  
€ 337,59 incl. btw

**197624-2**

POWERPACK 18V 2 x 5,0 Ah



€ 299,00 excl. btw  
€ 361,79 incl. btw

**197629-2**

POWERPACK 18V 2 x 5,0 Ah



€ 349,00 excl. btw  
€ 422,29 incl. btw

**197626-8**

POWERPACK 18V 4 x 5,0 Ah



€ 529,00 excl. btw  
€ 640,09 incl. btw

**198116-4**

Powerpack 18V 2 x 6,0 Ah



€ 329,00 excl. btw  
€ 398,09 incl. btw

**198077-8**

POWERPACK 18V 2 x 6,0 Ah



€ 379,00 excl. btw  
€ 458,59 incl. btw

**198091-4**

POWERPACK 18V 4 x 6,0 Ah



€ 569,00 excl. btw  
€ 688,49 incl. btw

**198170-8**

Accu timer LXT BPS01  
Programmeert de werkingsduur  
van 14,4V & 18V accu's



€ 134,70 excl. btw  
€ 163,00 incl. btw

**195584-2**

OPLADER DC18RC

Snellader voor LXT accu's van 14,4/18V



€ 85,00 excl. btw  
€ 102,85 incl. btw

**196933-6**

DUBBELLADER DC18RD

Duo snellader voor LXT accu's: 14,4/18V



2 accu's BL1850 laden  
in 45 minuten

€ 145,00 excl. btw  
€ 175,45 incl. btw

**198720-9**

OPLADER DC18RE

Snellader voor zowel CXT als LXT accu's



**LXT**

**CXT**

€ 139,00 excl. btw  
€ 168,19 incl. btw

**196426-3**

Oplader DC18SF

Traaglader voor LXT accu's, 4 poorten  
Laadt twee accu's tegelijk op



€ 199,00 excl. btw  
€ 240,79 incl. btw

ACCU BOOR- EN SCHROEFMACHINE

**14.4V**  
LITHIUM-ION



incl. 59 accessoires

DDF343RYX2

**DDF343RYX2**

Spanning	14,4 V	
Bijgeleverde accu's	2 x BL1415N	
Hard koppel	36 Nm	
Boorkop	1-10 mm	
Gewicht	1,4 kg	
Prijs in €	excl. btw	€ 289,00
	incl. btw	€ 349,69

ACCU (KLOP-)BOOR- EN SCHROEFMACHINE

**18V**  
LITHIUM-ION



DHP453RFX2

incl. 96 accessoires

**DHP453RFX2**

Spanning	18 V	
Bijgeleverde accu's	2 x BL1830B	
Hard koppel	42 Nm	
Boorkop	1,5-13 mm	
Gewicht	1,7 kg	
Prijs in €	excl. btw	€ 355,00
	incl. btw	€ 429,55

ACCU (KLOP-)BOOR- EN SCHROEFMACHINES

**MAK PAC**

**18V**  
LITHIUM-ION



DDF484RT3J



DDF486RT3J

**PROMO**

3e accu

	DDF453RF3J	DDF482RT3J	DDF484RT3J	DDF486RT3J	DHP486RT3J	
Spanning	18 V	18 V	18 V	18 V	18 V	
Bijgeleverde accu's	3 x BL1830B	3 x BL1850B	3 x BL1850B	3 x BL1850B	3 x BL1850B	
BL-motor	-	-	✓	✓	✓	
Klopboorfunctie	-	-	-	-	✓	
Hard koppel	42 Nm	62 Nm	54 Nm	130 Nm	130 Nm	
Boorkop	1,5-13 mm	1,5-13 mm	1,5-13 mm	1,5 - 13 mm	1,5 - 13 mm	
Gewicht	1,7 kg	1,7 kg	1,5 kg	2,3 - 2,6 kg	2,3 - 2,7 kg	
Prijs in €	excl. btw	€ 325,00	€ 425,00	€ 499,00	€ 539,00	€ 569,00
	incl. btw	€ 393,25	€ 514,25	€ 603,79	€ 652,19	€ 688,49

ACCU (KLOP-)BOOR- EN SCHROEFMACHINES



**DDF489/DHP489**

- Uiterst krachtige en compacte machine voor all-round gebruik
- Volledig metalen boorkop



	DDF083ZJ	DDF487RAJ	DDF485RTJ
Spanning	18 V	18 V	18 V
Bijgeleverde accu's	-	2 x BL1820	2 x BL1850B
Klopboorfunctie	-	-	-
Hard koppel	40 Nm	40 Nm	50 Nm
Opname	1/4 hex	1,5 - 13 mm	1,5-13 mm
Gewicht	1,1 - 1,4 kg	1,3 - 1,6 kg	1,4 kg
Prijs in €	excl. btw	€ 149,00	€ 325,00
	incl. btw	€ 180,29	€ 393,25

Wist je dat er van DDF484 en DHP486 ook de voordelige uitvoeringen DDF484Z / DDF484T1J en DHP486Z / DHP486T1J bestaan? Zie p. 52 - 53 voor meer info!

**NIEUW**

**NIEUW**

	DDF484RTJ	DDF489RTJ	DDF486RTJ	DHP487RAJ	DHP485RFJ	DHP484RTJ	DHP489RTJ	DHP486RTJ
Spanning	18 V	18 V	18 V	18 V	18 V	18 V	18 V	18 V
Bijgeleverde accu's	2 x BL1850B	2 x BL1850B	2 x BL1850B	2 x BL1820	2 x BL1830B	2 x BL1850B	2 x BL1850B	2 x BL1850B
Klopboorfunctie	-	-	-	✓	✓	✓	✓	✓
Hard koppel	54 Nm	73 Nm	130 Nm	40 Nm	50 Nm	54 Nm	73 Nm	130 Nm
Opname	1,5-13 mm	1,5-13 mm	1,5-13 mm	1,5 - 13 mm	1,5-13 mm	1,5-13 mm	1,5 - 13 mm	1,5 - 13 mm
Gewicht	1,6 - 2,2 kg	1,8 - 2,5 kg	2,3 - 2,7 kg	1,3 - 1,6 kg	1,4 - 1,7 kg	1,6 - 2,2 kg	1,8 - 2,5 kg	2,3 - 2,7 kg
Prijs in €	excl. btw	€ 415,00	€ 435,00	€ 465,00	€ 329,00	€ 285,00	€ 425,00	€ 455,00
	incl. btw	€ 502,15	€ 526,35	€ 562,65	€ 398,09	€ 344,85	€ 514,25	€ 550,55

ACCU HAAKSE BOORMACHINES



	DDA350RTJ	DDA351RTJ	DDA450RTE	DDA460ZK
Spanning	18 V	18 V	18 V	2 x 18 V
Bijgeleverde accu's	2 x BL1850B	2 x BL1850B	2 x BL1850B	-
Toerental	0-1800 t.p.m.	0-1800 t.p.m.	0 - 450 t.p.m. 0 - 1400 t.p.m.	0-350 t.p.m. 0-1400 t.p.m.
BL motor	-	-	✓	✓
XPT	-	-	✓	✓
Hard koppel	13,7 Nm	13,7 Nm	26/70 Nm	70/136 Nm
Boorkop	1,5-10 mm	1,5-10 mm	1,5-13 mm	1,5-13 mm
Gewicht	1,8 kg	1,8 kg	3,2 kg	5,7 kg
Prijs in €	excl. btw	€ 475,00	€ 475,00	€ 565,00
	incl. btw	€ 574,75	€ 574,75	€ 683,65

ACCU BIKHAMER SDS-PLUS



DHK180RTJ



		DHK180ZJ	DHK180RTJ
Spanning		18V	18V
Bijgeleverde accu's		0	2 x BL1850B
Slagenergie		3,1 J	3,1 J
Slagfrequentie		0 - 3200/min	0 - 3200/min
Triaxiale vibratiewaarde (ah)		4,5 m/s <sup>2</sup>	4,5 m/s <sup>2</sup>
Gewicht		3,3 kg	3,3 kg
Prijs in €	excl. btw	€ 539,00	€ 775,00
	incl. btw	€ 652,19	€ 937,75

ACCU BOORHAMERS SDS-PLUS



DHR171RTJ



**PROMO**

Gratis 3e BL1850B bij DHR243RTJ



DHR202RTJ



DHR182RTWJ



DHR243RTJ



DHR183RTWJ

**PROMO**

Gratis 17-delige booren bitset D-42444 bij DHR243Z en DHR243T1J



Wist je dat er van DHR243 ook de voordelige uitvoeringen DHR243Z en DHR243T1J bestaan? Zie p. 52-53 voor meer info!

DHR182RTWJ  
DHR243RTJW  
DHR183RTWJ  
incl. STOF AFZUIGING



		DHR171RTJ	DHR183RTWJ	DHR202RTJ	DHR182RTJ	DHR182RTWJ	DHR243RTJ	DHR243RTJW
Spanning		18V	18V	18V	18V	18V	18V	18V
Bijgeleverde accu's		2 x BL1850B	2 x BL1850B	2 x BL1850B	2 x BL1850B	2 x BL1850B	2 x BL1850B	2 x BL1850B
Slagenergie		1,2 J	1,7 J	2 J	1,7 J	1,7 J	2 J	2 J
Max. Ø beton		16 mm	16 mm	20 mm	18 mm	18 mm	24 mm	24 mm
BL-motor		✓	✓	-	✓	✓	✓	✓
AVT		-	✓	-	✓	✓	-	-
AWS		-	-	-	✓ excl. Bluetooth unit	✓ excl. Bluetooth unit	-	-
Stofafzuigingsysteem		-	DX16	-	-	DX05	-	DX07
Gewicht		2,1 kg	2,1 - 2,8 kg	3,5 kg	2,4 kg	3,3 kg	3,2 kg	4,7 kg
Prijs in €	excl. btw	€ 485,00	€ 539,00	€ 489,00	€ 509,00	€ 529,00	€ 599,00	€ 639,00
	incl. btw	€ 586,85	€ 652,19	€ 591,69	€ 615,89	€ 640,09	€ 724,79	€ 773,19

# Technologie

## AFT

### Active feedback sensing technology

Deze technologie schakelt de motor onmiddellijk uit bij het plots blokkeren van de machine. Sommige machines maken daarbij gebruik van een accelerometer die de zwenkbeweging van de machine detecteert. De AFT-technologie verhoogt de veiligheid enorm.

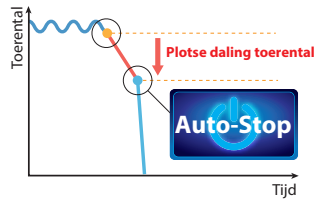

## AVT

### Anti-vibration technology

Het AVT-systeem reduceert trillingen drastisch door het gebruik van een systeem met bewegend tegengewicht, hetgeen het gebruikscomfort sterk verbetert.

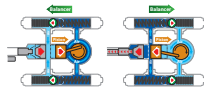

### Auto-start wireless system

Dankzij AWS wordt de stofafzuiging bij accu-toestellen automatisch geactiveerd d.m.v. een Bluetooth®-verbinding.



## ACCU COMBIHAMERS SDS-PLUS



DHR283G2JU



DHR264PT2J

**AWS**  
**AVT**  
**AFT**

DHR283ZWJU  
inclusief  
STOFAFZUIGING



Alle modellen  
INCLUSIEF extra  
automatische  
boorkop



	DHR264PT2J	DHR283ZJU	DHR283ZWJU	DHR283G2JU
Spanning	2 x 18V	2 x 18V	2x18V	2 x 18V
Bijgeleverde accu's	2 x BL1850B	0	0	2 x BL1860B
BL-motor	-	✓	✓	✓
Slagenergie	2,5 J	2,8 J	2,8 J	2,8 J
Max. Ø beton	26 mm	28 mm	28 mm	28 mm
AWS	-	✓	✓	✓
AVT	-	✓	✓	✓
AFT	-	✓	✓	✓
Stofafzuigstelsysteem	-	-	DX09	-
Gewicht	4,2 kg	4,0 kg	5,5 kg	4,0 kg
Prijs in €	excl. btw	€ 639,00	€ 519,00	€ 569,00
	incl. btw	€ 773,19	€ 627,99	€ 688,49
		€ 775,00	€ 937,73	

# PREMIUM BEITELSET SDS-PLUS EN SDS-MAX

- ✓ 2 keer langere levensduur dan de standaard beitels!
- ✓ Zeer efficiënt: vormvast. Het afbraakwerk is veel productiever!

## 3-DELIGE PREMIUM BEITELSET SDS-PLUS

**SDS- PLUS**

**E-20220**

€ 57,50  
excl. btw

€ 69,58  
incl. btw



1 puntbeitel 250 mm  
1 koudbeitel 20 x 250 mm  
1 platte beitel 40 x 250 mm



### AntiJam™ ontwerp

Verhoogt de productiviteit  
Vermindert de wrijving en de kans op blokkeren  
Speciaal ontworpen voor SDS-PLUS machines



## 5-DELIGE PREMIUM BEITELSET SDS-MAX

**SDS- MAX**

**E-20236**

€ 135,00  
excl. btw

€ 163,35  
incl. btw

**NIEUW**



2 puntbeitels 400 mm  
2 koudbeitels 25 x 400 mm  
1 platte beitel 40 x 250 mm



### BreakPower™ ontwerp

Verhoogt de productiviteit  
Vermindert de wrijving en de kans op blokkeren  
Speciaal ontworpen voor SDS-MAX machines

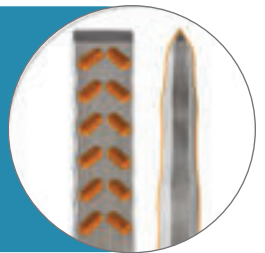

## ACCU COMBIHAMER SDS-MAX

**BL MOTOR AVT**

**AWS** 18V + 18V → 36V



DHR400ZKU1  
incl. stofafzuiging 199142-6

**DHR400ZKUN DHR400ZKU1 DHR400G2UN**

Spanning	2 x 18V	2 x 18V	2 x 18V
Bijgeleverde accu's	-	-	2 x BL1860B
Slagenergie	8 J	8 J	8 J
Max. Ø beton	40 mm	40 mm	40 mm
Vibratieniveau hamerboren	5,0 m/s <sup>2</sup>	5,0 m/s <sup>2</sup>	5,0 m/s <sup>2</sup>
AWS	✓	✓	✓
AFT	✓	-	✓
Gewicht	8,1 kg	8,1 kg	8,1 kg
Prijs in €	excl. btw	€ 799,00	€ 799,00
	incl. btw	€ 966,79	€ 966,79
			€ 1.039,00
			€ 1.257,19

## ACCU HETELUCHTPISTOLEN

**18V LITHIUM-ION**



DHG180RT1J



DHG181RT1J

- Snelle wissel van het mondstuk
- Veilige schakelaar, te blokkeren in uit en aan stand
- Verschillende mondstukken zijn inbegrepen

		<b>DHG180RT1J</b>	<b>DHG181RT1J</b>
Spanning		18V	18V
Bijgeleverde accu's		1x BL1850B	1x BL1850B
Temperatuurbereik		550 °C	6 standen, max 550 °C
Debiet		200 l/min	120 l/min, 200 l/min
Gewicht		1,0 - 1,3 kg	1,0 - 1,4 kg
Prijs in €	excl. btw	€ 285,00	€ 305,00
	incl. btw	€ 344,85	€ 369,05



ACCU SLAGMOERSLEUTELS



**Auto-stop:**  
de machine stopt automatisch van zodra de bout of moer voldoende is losgedraaid

**PROMO**

gratis 87-delige gereedschapsset E-08458 bij DTW300RTJ

Wist je dat er van DTW300 de voordelige uitvoeringen DTW300Z en DTW300TJ bestaan? Zie p. 52-53 voor meer uitleg!



DTW1001RTJ



DTW190RTJ



DTW300RTJ



DTW700RTJ



DTW181RTJ

	DTW181RTJ	DTW190RTJ	DTW300RTJ	DTW700RTJ	DTW1001RTJ	DTW1002RTJ	
Spanning	18V	18V	18V	18V	18V	18V	
Bijgeleverde accu's	2 x BL1850B	2 x BL1850B	2 x BL1850B	2 x BL1850B	2 x BL1850B	2 x BL1850B	
BL-motor	✓	-	✓	✓	✓	✓	
XPT	✓	-	✓	✓	-	-	
Toerental	0-2400 tpm.	0-2400 tpm.	0-3200 tpm.	0-2200 tpm.	0-1800 t.p.m.	0-1800 t.p.m.	
Max. koppel	180 Nm	190 Nm	330 Nm	700 Nm	1050 Nm	1000 Nm	
Dopaansluiting	1/2" vierkant	1/2" vierkant	1/2" vierkant	1/2" vierkant	3/4" vierkant	1/2" vierkant	
Auto-stop functie	✓	-	✓	✓	-	-	
Gewicht	1,2 kg	1,4 kg	1,8 kg	2,6 kg	3,4 kg	3,3 kg	
Prijs in €	excl. btw	€ 429,00	€ 399,00	€ 529,00	€ 605,00	€ 649,00	€ 645,00
	incl. btw	€ 519,09	€ 482,79	€ 640,09	€ 732,05	€ 785,29	€ 780,45

ACCU RATELMOERSLEUTEL



Geleverd met 1/4" & 3/8" opname

Verwijderbare kop laat toe om 13 mm moeren over de lengte van een M8 draadstang te schroeven.



DWR180ZJ

	DWR180ZJ	DWR180RA1J	
Spanning	18V	18V	
Bijgeleverde accu's	0	1 x BL1820B	
Toerental onbelast	0-800 t.p.m.	0-800 t.p.m.	
Max. koppel	47,5 Nm	47,5 Nm	
Gewicht	1,2 kg	1,2 kg	
Prijs in €	excl. btw	€ 205,00	€ 299,00
	incl. btw	€ 248,05	€ 361,79

ACCU BREEKMOERSLEUTEL



- Voor het vastdraaien van torsiebreekbouten met een hoge trekvastheid (type HRC/tor-shear).
- Torsiebreekbouten worden vooral gebruikt bij industriële staalconstructies.

	DWT310ZK	
Spanning	2x18V	
Bijgeleverde accu's	-	
Toerental onbelast	14 min <sup>-1</sup>	
Max. koppel	804 Nm	
Gewicht	6,5 - 7,1 kg	
Prijs in €	excl. btw	€ 1.719,00
	incl. btw	€ 2.079,99



# Impact PREMIER

## ACCESSOIRES

# IMPACT PREMIER

**Duurzamer door de dubbele torsie!**



**E-13568**  
5-delige schroefbitset



€14,20 excl. btw  
€17,20 incl. btw

**Past zeer nauwkeurig in de schroef.**

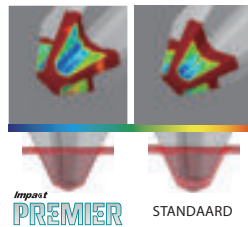

**E-03567**  
11-delige schroefbitset



€27,80 excl. btw  
€33,60 incl. btw

**Gebruik van hoogwaardig staal. Ondersteunt een hoog koppel.**

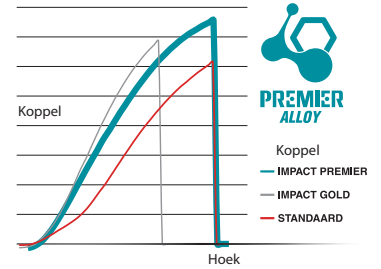

**E-13552**  
31-delige schroefbitset



€55,00 excl. btw  
€66,55 incl. btw

		Excl. BTW	Incl. BTW
E-03121	Schroefbit IMPACT PREMIER PH1-25 mm, 2 stks	€ 4,40	€ 5,30
E-03137	Schroefbit IMPACT PREMIER PH2-25 mm, 2 stks	€ 4,40	€ 5,30
E-03143	Schroefbit IMPACT PREMIER PH2(slim)-25 mm, 2 stks	€ 4,40	€ 5,30
E-03159	Schroefbit IMPACT PREMIER PH3-25 mm, 2 stks	€ 4,40	€ 5,30
E-03165	Schroefbit IMPACT PREMIER PZ1-25 mm, 2 stks	€ 4,40	€ 5,30
E-03171	Schroefbit IMPACT PREMIER PZ2-25 mm, 2 stks	€ 4,40	€ 5,30
E-03187	Schroefbit IMPACT PREMIER PZ3-25 mm, 2 stks	€ 4,40	€ 5,30
E-03193	Schroefbit IMPACT PREMIER T10-25 mm, 2 stks	€ 4,40	€ 5,30
E-03202	Schroefbit IMPACT PREMIER T15-25 mm, 2 stks	€ 4,40	€ 5,30
E-03218	Schroefbit IMPACT PREMIER T20-25 mm, 2 stks	€ 4,40	€ 5,30
E-03224	Schroefbit IMPACT PREMIER T25-25 mm, 2 stks	€ 4,40	€ 5,30
E-03230	Schroefbit IMPACT PREMIER T30-25 mm, 2 stks	€ 4,40	€ 5,30
E-20242	Schroefbit IMPACT PREMIER T40-25 mm, 2 stks	€ 4,90	€ 5,93
E-03246	Schroefbit IMPACT PREMIER PH2-25 mm, 15 stks Flip top	€ 22,20	€ 26,90
E-03252	Schroefbit IMPACT PREMIER PZ2-25 mm, 15 stks Flip top	€ 22,20	€ 26,90

E-03268	Schroefbit IMPACT PREMIER PH1-50 mm, 2 stks	€ 6,00	€ 7,30
E-03274	Schroefbit IMPACT PREMIER PH2-50 mm, 2 stks	€ 6,00	€ 7,30
E-03280	Schroefbit IMPACT PREMIER PH3-50 mm, 2 stks	€ 6,00	€ 7,30
E-03296	Schroefbit IMPACT PREMIER PZ1-50 mm, 2 stks	€ 6,00	€ 7,30
E-03305	Schroefbit IMPACT PREMIER PZ2-50 mm, 2 stks	€ 6,00	€ 7,30
E-03311	Schroefbit IMPACT PREMIER PZ3-50 mm, 2 stks	€ 6,00	€ 7,30
E-03327	Schroefbit IMPACT PREMIER T10-50 mm, 2 stks	€ 6,00	€ 7,30
E-03333	Schroefbit IMPACT PREMIER T15-50 mm, 2 stks	€ 6,00	€ 7,30
E-03349	Schroefbit IMPACT PREMIER T20-50 mm, 2 stks	€ 6,00	€ 7,30
E-03355	Schroefbit IMPACT PREMIER T25-50 mm, 2 stks	€ 6,00	€ 7,30
E-03361	Schroefbit IMPACT PREMIER T30-50 mm, 2 stks	€ 6,00	€ 7,30
E-12027	Schroefbit IMPACT PREMIER T40-50 mm, 2 stks	€ 6,00	€ 7,30
E-03377	Schroefbit IMPACT PREMIER PH2-50 mm, 10 stks Flip top	€ 22,30	€ 27,00
E-03383	Schroefbit IMPACT PREMIER PZ2-50 mm, 10 stks Flip top	€ 22,30	€ 27,00

		Excl. BTW	Incl. BTW
E-06286	Dubbelbit IMPACT PREMIER PH2-65 mm, 2 stks	€ 8,70	€ 10,50
E-06292	Dubbelbit IMPACT PREMIER PZ2-65 mm, 2 stks	€ 8,70	€ 10,50
E-03399	IMPACT PREMIER Torsion bithouder 68 mm	€ 9,70	€ 11,70
E-03408	IMPACT PREMIER Torsion bithouder 150 mm	€ 10,70	€ 12,90
E-03414	ULTRA MAG bithouder IMPACT PREMIER TORSION	€ 14,80	€ 17,90
E-03420	IMPACT PREMIER Tilt adapter 1/4" voor krachtdoppen 3/8" - 50 mm	€ 8,50	€ 10,30
E-03436	IMPACT PREMIER Tilt adapter 1/4" voor krachtdoppen 1/2" - 50 mm	€ 9,00	€ 10,90
E-03442	IMPACT PREMIER Mag Boost magneet voor schroefbits	€ 4,00	€ 4,80
E-03458	IMPACT PREMIER Torsion dopsleutel H6-65 mm	€ 5,20	€ 6,30
E-03464	IMPACT PREMIER Torsion dopsleutel H8-65 mm	€ 7,00	€ 8,50
E-03470	IMPACT PREMIER Torsion dopsleutel H10-65 mm	€ 7,00	€ 8,50
E-03486	IMPACT PREMIER Torsion dopsleutel H13-65 mm	€ 8,00	€ 9,70
E-03492	IMPACT PREMIER krachtdop H13-80 mm	€ 10,80	€ 13,10
E-03501	IMPACT PREMIER krachtdop H15-80 mm	€ 11,40	€ 13,80
E-03517	IMPACT PREMIER krachtdop H17-80 mm	€ 11,40	€ 13,80
E-03523	IMPACT PREMIER krachtdop H19-80 mm	€ 11,60	€ 14,04
E-03539	IMPACT PREMIER krachtdop H21-80 mm	€ 12,20	€ 14,80
E-03573	11-delige IMPACT PREMIER schroefbitset	€ 27,80	€ 33,60



ACCU HAAKSE  
SLAGSCHROEVENDRAAIER



DTL061RTJ

Spanning	18 V	
Bijgeleverde accu's	2 x BL1850B	
Toerental	0-2000 t.p.m.	
Gewicht	1,8 kg	
Prijs in €	excl. btw	€ 519,00
	incl. btw	€ 627,99

ACCU SLAGSCHROEVENDRAAIERS



Assist mode: voor het vlot aanzetten bij het schroeven.

T-modus: instelling voor zelftappende schroeven.



DTD157RTJ



DTD153RTJ



DTD172RTJ

PROMO

gratis  
neusadapter  
194281-7 bij  
DTD153RTJ



Wist je dat er van DTD153 de voordelige uitvoeringen DTD153Z en DTD153T1J bestaan? Zie p. 52-53 voor meer info!

	DTD156RTJ	DTD153RTJ	DTD157RTJ	DTD154RTJ	DTD172RTJ	
Spanning	18 V	18 V	18 V	18 V	18 V	
Bijgeleverde accu's	2 x BL1850B	2 x BL1850B	2 x BL1850B	2 x BL1850B	2 x BL1850B	
BL-motor	-	✓	✓	✓	✓	
Toerental	0-2500 t.p.m.	0-3400 t.p.m.	0-3000 t.p.m.	0-3600 t.p.m.	0-3600 t.p.m.	
Max. koppel	155 Nm	170 Nm	140 Nm	175 Nm	180 Nm	
Bitopname	1/4" hex.	1/4" hex.	1/4" hex.	1/4" hex.	1/4" hex.	
Slagkrachtniveau	-	-	2	3	4	
T-modus	-	-	-	✓	✓	
Assist mode	-	-	✓	-	✓	
Gewicht	1,3 kg	1,5 kg	1,2 kg	1,5 kg	1,5 kg	
Prijs in €	excl. btw	€ 379,00	€ 419,00	€ 395,00	€ 455,00	€ 479,00
	incl. btw	€ 458,59	€ 506,99	€ 477,95	€ 550,55	€ 579,59

ACCU HYBRIDE  
BOOR- EN SCHROEFMACHINE



DTP141RTJ

4 modi: klopboren, boren schroeven, slag Schroeven

	DTP141ZJ	DTP141RTJ	
Spanning	18 V	18 V	
Bijgeleverde accu's	-	2 x BL1850B	
Toerental	0-2700 t.p.m.	0-2700 t.p.m.	
Gewicht	1,8 kg	1,8 kg	
Prijs in €	excl. btw	€ 319,00	€ 579,00
	incl. btw	€ 385,99	€ 700,59

ACCU HYDRAULISCHE  
SLAGSCHROEVENDRAAIER



DTS141ZJ

Uiterst stil dankzij het unieke hydraulische impulsstelsel

	DTS141ZJ	
Spanning	18 V	
Bijgeleverde accu's	-	
Toerental	0-3200 t.p.m.	
Max. koppel	40 Nm	
Bitopname	1/4" hex	
T-modus	✓	
Gewicht	1,5 kg	
Prijs in €	excl. btw	€ 459,00
	incl. btw	€ 555,39

ACCU PINPISTOOL  
23 Ga



DPT353RTJ

Spanning	18 V	
Bijgeleverde accu's	2 x BL1850B	
Doorsnede nagel	0,6 mm	
Lengte nagel	15-35 mm	
Gewicht	2,0 kg	
Prijs in €	excl. btw	€ 599,00
	incl. btw	€ 724,79

ACCU NIETMACHINES



DST221RTJ

DST221:  
Aluminium magazijn

DST112RTJ DST221RTJ

Spanning	18 V	18 V	
Bijgeleverde accu's	2 x BL1850B	2 x BL1850B	
Rugbreedte niet	10 mm	10,5 mm	
Lengte niet	7-10 mm	10-22 mm	
Gewicht	1,5 kg	2,1 kg	
Prijs in €	excl. btw	€ 569,00	€ 589,00
	incl. btw	€ 688,49	€ 712,69

ACCU MINIBRADPISTOLEN  
18 Ga



DFN350RTJ



DBN500RTJ

DFN350RTJ DBN500RTJ

Spanning	18 V	18 V	
Bijgeleverde accu's	2 x BL1850B	2 x BL1850B	
Doorsnede nagel	1,2 mm	1,2 mm	
XPT	✓	-	
Lengte nagel	15-35 mm	15-50 mm	
Gewicht	2,1 kg	3,2 kg	
Prijs in €	excl. btw	€ 639,00	€ 719,00
	incl. btw	€ 773,19	€ 869,99

Voor zacht hout

ACCU BRADPISTOOL  
16 Ga



Voor zacht hout

DBN600RTJ

Spanning	18 V	
Bijgeleverde accu's	2 x BL1850B	
Doorsnede nagel	1,6 mm	
Lengte nagel	25-64 mm	
Gewicht	3,4 kg	
Prijs in €	excl. btw	€ 745,00
	incl. btw	€ 901,45

ACCU LAMELLENFREES



DPJ180RTJ

Spanning	18 V	
Bijgeleverde accu's	2 x BL1850B	
Toerental	6500 t.p.m.	
Gewicht	3,2 kg	
Prijs in €	excl. btw	€ 509,00
	incl. btw	€ 615,89

ACCU SCHAAF



DKP181RTJU



DKP181RTJU

Spanning	18 V	
Bijgeleverde accu's	2 x BL1850B	
Toerental	12000 t.p.m.	
Schaafbreedte	82 mm	
Max. spaanafname	3 mm	
Sponningdiepte	25 mm	
AWS	✓	
Gewicht	3,3 kg	
Prijs in €	excl. btw	€ 595,00
	incl. btw	€ 719,95

ACCU RECIPROZAGEN



**DJR189**

- Kan met één hand gebruikt worden
- Uitstekend geschikt voor het zagen in nauwe ruimten en in de hoogte
- Uitermate licht en toch zeer krachtig
- Trillingsarm (anti-vibratiesysteem met bewegend tegengewicht)

	DJR189ZJ	DJR183RTJ	DJR186RTE	DJR187RTE	DJR188RTJ	DJR360PT2	
Spanning	18V	18V	18V	18V	18V	2 x 18V	
Bijgeleverde accu's	-	2 x BL1850B	2 x BL1850B	2 x BL1850B	2 x BL1850B	2 x BL1850B	
Bijgeleverde lader	-	DC18RC	DC18RC	DC18RC	DC18RC	DC18RD	
BL-motor	✓	-	-	✓	✓	✓	
Toerental	0-3100 /min	0-3300 /min	0-2800 /min	0-3000 /min	0-3000 /min	0-3000 /min	
Slaglengthe	22 mm	13 mm	32 mm	32 mm	20 mm	32 mm	
Max. capaciteit hout	255 mm	50 mm	255 mm	255 mm	255 mm	255 mm	
Gewicht	2,2 - 2,5 kg	1,6 kg	3,5 kg	3,4 kg	2,9 kg	4,6 kg	
Prijs in €	excl. btw	€ 215,00	€ 399,00	€ 435,00	€ 499,00	€ 455,00	€ 559,00
	incl. btw	€ 260,15	€ 482,79	€ 526,35	€ 603,79	€ 550,55	€ 676,39

ACCU DECOUPEERZAGEN

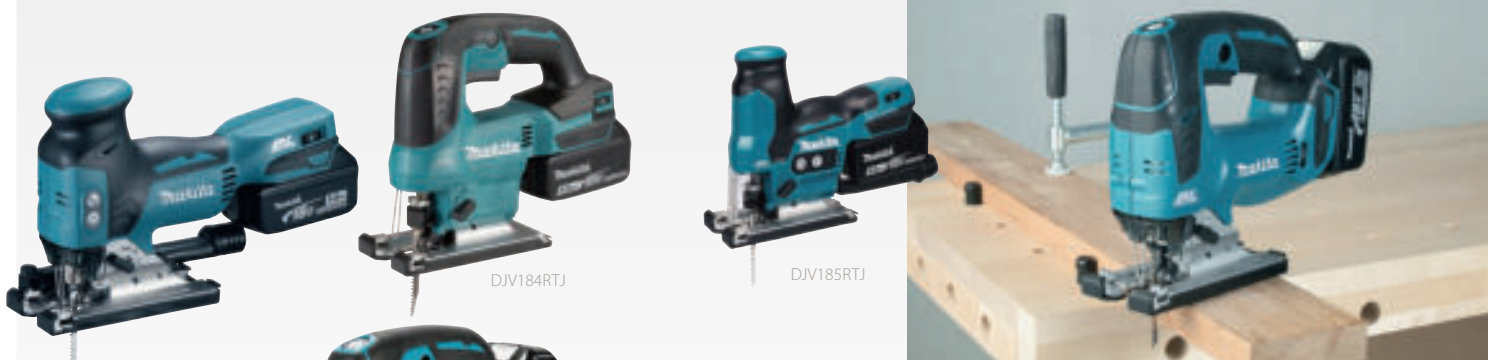

Wist je dat er van DJV181 en DJ182 de voordelige uitvoeringen DJV181Z / DJV181T1J en DJV182Z / DJV182T1J bestaan? Zie p. 52-53 voor meer info!

	DJV184RTJ	DJV185RTJ	DJV181RTJ	DJV182RTJ	
Spanning	18V	18V	18V	18V	
Bijgeleverde accu's	2 x BL1850B	2 x BL1850B	2 x BL1850B	2 x BL1850B	
BL motor	✓	✓	✓	✓	
Aantal zaagbewegingen	0-3000 min <sup>-1</sup>	800-3000 min <sup>-1</sup>	800-3500 min <sup>-1</sup>	800-3500 min <sup>-1</sup>	
Max. capaciteit hout	135 mm	135 mm	135 mm	135 mm	
Slaglengthe	23 mm	23 mm	26 mm	26 mm	
Gewicht	2,1 - 2,4 kg	2,0 - 2,3 kg	2,3 - 2,6 kg	2,4 - 2,7 kg	
Prijs in €	excl. btw	€ 439,00	€ 439,00	€ 519,00	€ 519,00
	incl. btw	€ 531,19	€ 531,19	€ 627,99	€ 627,99

ACCU INVALCIRKELZAGEN  
165 mm

18V → 18V → 36V



Geleiderail  
194368-5 bij PT2J1



DSP600PT2J1

DSP601ZJU DSP600PT2J DSP600PT2J1

	DSP601ZJU	DSP600PT2J	DSP600PT2J1	
Spanning	2 x 18V	2 x 18V	2 x 18V	
Bijgeleverde accu's	0	2 x BL1850B	2 x BL1850B	
Zaagdiepte	56 mm	56 mm	56 mm	
Diameter asgat	20 mm	20 mm	20 mm	
AWS	✓	-	-	
Aantal MAKPAC-koffers	1	2	2	
Gewicht	4,4 kg	4,4 kg	4,4 kg	
Prijs in €	excl. btw	€ 469,00	€ 689,00	€ 749,00
	incl. btw	€ 567,49	€ 833,69	€ 906,29

ACCU METAALCIRKELZAGEN



18V  
LITHIUM-ION



DCS552RTJ

DCS553RTJ

DCS552RTJ DCS553RTJ

	DCS552RTJ	DCS553RTJ	
Spanning	18V	18V	
Bijgeleverde accu's	2 x BL1850B	2 x BL1850B	
BL-motor	-	✓	
Ø zaagblad	136 mm	150 mm	
Zaagdiepte (90°)	50,5 mm	57,5 mm	
Gewicht	2,4 kg	3,0 kg	
Prijs in €	excl. btw	€ 489,00	€ 549,00
	incl. btw	€ 591,69	€ 664,29

COMBOPACK



DSP600

BL1850B

DJV182

DC18RD

DLX2234PX1

Invalcirkelzaag	DSP600	
Bijgeleverde accu's	2 x BL1850B	
Decoupeerzaag	DJV182	
Lader	DC18RD	
Prijs in €	excl. btw	€ 859,00
	incl. btw	€ 1.039,39

ACCU CIRKELZAGEN



18V → 18V → 36V

18V  
LITHIUM-ION



DHS660RTJ

DHS782PT2J

DHS680RTJ

Promo DHS680RTJ:  
gratis 3e BL1850B



Wist je dat er van DHS680 de voordelige uitvoeringen DHS680Z en DHS680TJ bestaan? Zie p. 52-53 voor meer info!

DHS782, DHS783 & DHS900  
passen rechtstreeks op  
geleiderail

	DSS501RTJ	DHS680RTJ	DHS660RTJ	DHS661RTJU	DHS630RTJ	DHS710PT2J	DHS782PT2J	DHS783T2JU	DHS900PT2	DHS900PT2U
Spanning	18V	18V	18V	18V	18V	2 x 18V	2 x 18V	2 x 18V	2 x 18V	2 x 18V
Bijgeleverde accu's	2 x BL1850B	2 x BL1850B	2 x BL1850B	2 x BL1850B	2 x BL1850B	2 x BL1850B	2 x BL1850B	2 x BL1850B	2 x BL1850B	2 x BL1850B
BL-motor	✓	✓	✓	✓	-	-	✓	✓	✓	✓
Zaagdiepte (90°)	51 mm	57 mm	57 mm	57 mm	66 mm	68,5 mm	62,5 mm	62,5 mm	85 mm	85 mm
Ø zaagblad	136 mm	165 mm	165 mm	165 mm	165 mm	190 mm	190 mm	190 mm	235 mm	235 mm
AWS	-	-	-	✓	-	-	-	✓	✓	✓
Gewicht	2,7 kg	3,3 kg	3,4 kg	3,4 kg	3,5 kg	4,7 kg	4,5 kg	4,5 kg	5,3 kg	5,3 kg
Prijs in €	excl. btw	€ 479,00	€ 579,00	€ 549,00	€ 579,00	€ 559,00	€ 609,00	€ 679,00	€ 719,00	€ 815,00
	incl. btw	€ 579,59	€ 700,59	€ 664,29	€ 700,59	€ 676,39	€ 736,89	€ 821,59	€ 869,99	€ 937,75

ACCU AFKORT-VERSTEKZAAG



DLS600RTE

Spanning	18V	
Bijgeleverde accu's	2 x BL1850B	
Ø zaagblad	165 mm	
Max. zaagcapaciteit bij 90°	46 x 92 mm	
Gewicht	6,6 kg	
Prijs in €	excl. btw	€ 895,00
	incl. btw	€ 1.082,95

# EFFICUT

Fijner, sneller en efficiënter snijden



Scan mij voor meer info!



Meer zaagsneden per batterijlading



Snel zagen



Langere levensduur



Zuivere zaagsnede



ACCU TELESCOPISCHE AFKORT-VERSTEKZAGEN



## DXT

Deep and Exact Cutting Technology

De gepatenteerde constructie met drievoudige tandwieloverbrenging en uitsparing achter de flens laat toe om een groter deel van het zaagblad te benutten. Daardoor kunnen ook hoge plinten verticaal of in verstek afgekort worden.



DLS211



DLS714N

DLS714NPT2 DLS111ZU DLS211ZU

Spanning	2 x 18V	2 x 18V	2 x 18V	
Bijgeleverde accu's	2 x BL1850B	promo: B-67290	promo: B-67315	
Ø Zaagblad	190 mm	260 mm	305 mm	
Zaagdiepte (90°)	52 mm	91 mm	107 mm	
Zaagbreedte (90°)	300 mm	310 mm	363 mm	
DXT	-	✓	✓	
AWS	-	✓	✓	
Gewicht	13,0 kg	27,3 kg	30,7 kg	
Prijs in €	excl. btw	€ 965,00	€ 865,00	€ 1.049,00
	incl. btw	€ 1.167,65	€ 1.046,65	€ 1.269,29

ACCU MENGER



Ideaal voor het mengen van vloeistoffen, verf en lichte lijmsorten.



INCLUSIEF BATTERIJCOVER

2 MECHANISCHE SNELHEDEN

DUT130RTE

Spanning	18V	
Bijgeleverde accu's	2 x BL1850B	
Diameter mengblad	165 mm	
Aansluiting	M12-M14	
Toerental	0-350 / 0-1300 t.p.m.	
Gewicht	2,5 kg	
Prijs in €	excl. btw	€ 589,00
	incl. btw	€ 712,69

ACCU LANGNEKSCHUURMACHINE 225 MM



Accessoires

Steunschijf

Type	Ref.	Prijs excl. btw	Prijs incl. btw
Zacht	199939-3	€ 72,50	€ 87,70
Medium	199940-8	€ 72,50	€ 87,70
Hard	199938-5	€ 72,50	€ 87,70

Schuurschijf 225 mm (per 25)

Korrel	Ref.	Prijs excl. btw	Prijs incl. btw
P40	B-68389	€ 40,20	€ 48,60
P80	B-68395	€ 40,20	€ 48,60
P120	B-68404	€ 36,70	€ 44,40
P180	B-68410	€ 40,20	€ 48,60
P320	B-68426	€ 40,20	€ 48,60



Telescopische buis  
De totale lengte van de machine kan aangepast worden van 1100 tot 1520 mm



Verlengstuk  
Met het optionele verlengstuk met steun (199937-7) kan langer comfortabel in de hoogte gewerkt worden.



DSL801RTEU

DSL800ZU



De beschermkap van de DSL800 heeft één rechte kant, dat laat toe dicht langs een muur of plafond te bewegen.



De beschermkap van de DSL801 is volledig rond, dit is gunstig voor de stofafvoer.

DSL800ZU DSL801ZU

Spanning	18V	18V
Bijgeleverde accu's	0	0
AWS	✓	✓
Toerental onbelast	1000-1800 t.p.m.	1000-1800 t.p.m.
Diameter schuurschijf	225 mm	225 mm
Lengte	1100 -1520 mm	1100 -1520 mm
Gewicht	4,8 kg	4,8 kg
Prijs in €	excl. btw	€ 639,00
	incl. btw	€ 773,19

ACCU GIPSFREES



DCO181Z

Spanning	18V	
Bijgeleverde accu's	0	
Toerental	0 - 32000 t.p.m.	
AWS	✓ excl. Bluetooth unit	
BL-Motor	✓	
Gewicht	1,4 kg	
Prijs in €	excl. btw	€ 225,00
	incl. btw	€ 272,25

ACCU GIPSAZAG



DSD180ZJ

Spanning	18V	
Bijgeleverde accu's	0	
Slaglengte	6 mm	
Gewicht	1,7 kg	
Prijs in €	excl. btw	€ 235,00
	incl. btw	€ 284,35



ACCU SCHROEFAUTOMATEN



• **"Push Drive"-technologie:** de motor start automatisch wanneer de neus van de machine tegen de ondergrond wordt gedrukt.



DFR551RTJ



DFR550RTJ

	DFR550RTJ	DFR750Z	DFR452RTJ	DFR551RTJ
Spanning	18V	18V	18V	18V
Bijgeleverde accu's	2xBL1850B	0	2xBL1850B	2xBL1850B
Toerental	4000 t.p.m.	4000 t.p.m.	6000 t.p.m.	6000 t.p.m.
BL motor	-	-	✓	✓
Ø Gipsplaatschroef	4,0 mm	4,0 mm	3,5-4,2 mm	3,5-4,2 mm
Schroeflengte	25-55 mm	45-75 mm	20-41 mm	25-55 mm
"Push drive" technologie	-	-	✓	✓
Gewicht	2,1 kg	2,1 kg	2,2 kg	2,2 kg
Prijs in €	excl. btw	€ 555,00	€ 299,00	€ 609,00
	incl. btw	€ 671,55	€ 361,79	€ 736,89

ACCU SCHROEVENDRAAIERS



**Duw-aandraaistand ("Push drive")**



In de duw-aandraaistand gaan de motor en de schroefkop automatisch draaien wanneer er druk op wordt uitgeoefend.



DFS250RTJ



DFS452FJX2

	DFS250RTJ	DFS452RAJ	DFS452FJX2
Spanning	18V	18V	18V
Bijgeleverde accu's	2 x BL1850B	2 x BL1820B	2 x BL1830B
Toerental	0-2500 t.p.m.	0- 4000 t.p.m.	0-4000 t.p.m.
Incl. schroeflintadapter	-	-	✓
Schroeflengte	-	-	25-55 mm
"Push drive" technologie	-	✓	✓
Gewicht	1,5 kg	1,5 kg	1,5 kg
Prijs in €	excl. btw	€ 439,00	€ 425,00
	incl. btw	€ 531,19	€ 514,25

ACCU BOVEN- EN KANTENFREES



	DRT50ZJX3	DRT50RTJX3	
Spanning	18V	18V	
Bijgeleverde accu's	0	2 x BL1850B	
Max. induikdiepte	35 mm	35 mm	
Toerental onbelast	10.000-30.000 t.p.m.	10.000-30.000 t.p.m.	
Ø spatang - bereik	6 - 8 mm	6 - 8 mm	
Ø spatang - inbegrepen	6 mm, 8 mm	6 mm, 8 mm	
Gewicht	2,1 kg	2,1 kg	
Prijs in €	excl. btw	€ 345,00	€ 559,00
	incl. btw	€ 417,45	€ 676,39

ACCU HANDPALMVLAKSCHUURMACHINES



DBO480: standaard met extra driehoekszool

Promo  
DBO480RTJ, DBO481RTJ  
en DBO482RTJ:  
gratis extra accu BL1830B



		DBO480RTJ	DBO481RTJ	DBO482RTJ	DBO484ZJ
Spanning		18 V	18 V	18 V	18 V
Bijgeleverde accu's		2x BL1850B	2x BL1850B	2x BL1850B	-
Afmetingen schuurvoet		112 mm x 102 mm	112 mm x 102 mm	112 mm x 102 mm	112 mm x 102 mm
Papierbevestiging		Klem/Velcro	Klem	Klem	Klem/Velcro
Materiaal schuurvoet		Kunststof	Kunststof	Aluminium	Aluminium
Aantal schuurbewegingen		22000/28000 min <sup>-1</sup>	22000/28000 min <sup>-1</sup>	22000/28000 min <sup>-1</sup>	22000/28000 min <sup>-1</sup>
Schuuruitslag		1,5 mm	1,5 mm	1,5 mm	1,5 mm
AWS ready		-	-	✓	✓
Gewicht		1,4-1,8 kg	1,4-1,8 kg	1,4-1,8 kg	1,4-1,8 kg
Prijs in €	excl. btw	€ 379,00	€ 359,00	€ 375,00	€ 139,00
	incl. btw	€ 458,59	€ 434,39	€ 453,75	€ 168,16

**NIEUW**

ACCU VLAKSCHUURMACHINES



DBO381RTJU



DBO382ZJ

**NIEUW**

		DBO380RTJ	DBO381RTJU	DBO382ZJ
Spanning		18 V	18 V	18 V
Bijgeleverde accu's		2x BL1850B	2x BL1850B	2x BL1850B
Afmetingen schuurvoet		92 mm x 185 mm	92 mm x 185 mm	92 mm x 185 mm
Papierbevestiging		Klem	Klem	Klem/velcro
Materiaal schuurvoet		Aluminium	Aluminium	Aluminium
Aantal schuurbewegingen		8000/16000/24000 min <sup>-1</sup>	8000/16000/24000 min <sup>-1</sup>	8000/16000/24000 min <sup>-1</sup>
Schuuruitslag		2,0 mm	2,0 mm	2,0 mm
AWS		-	✓	-
Gewicht		1,9 - 2,2 kg	1,9 - 2,2 kg	1,9 - 2,2 kg
Prijs in €	excl. btw	€ 405,00	€ 439,00	€ 189,00
	incl. btw	€ 490,05	€ 531,19	€ 228,69

ACCU EXCENTRISCHE SCHUURMACHINE 125 MM



DBO180

**DBO180RTJ**

Spanning		18 V
Bijgeleverde accu's		2 x BL1850B
Diameter schuurvoet		125 mm
Aantal schuurbewegingen		14000 - 22000 mm <sup>-1</sup>
Schuuruitslag		2,8 mm
Gewicht		1,7 kg
Prijs in €	excl. btw	€ 419,00
	incl. btw	€ 506,99

ACCU EXCENTRISCHE POLIJSTMACHINES



DPO500Z

Vrije rotatie en  
geforceerde rotatie

		DPO500Z	DPO600Z
Spanning		18 V	18 V
Bijgeleverde accu's		0	0
Oscillatiefrequentie		0-13600 min <sup>-1</sup>	0-13600 min <sup>-1</sup>
Schuurvoet		125 mm	150 mm
Schuuruitslag		5,5 mm	5,5 mm
Gewicht		3,1 kg	3,1 kg
Prijs in €	excl. btw	€ 365,00	€ 375,00
	incl. btw	€ 441,65	€ 453,75

ACCU BANDSCHUURMACHINE 9 MM



Hoog gebruikskomfort en  
perfecte balans door centrale  
plaatsing van de motor

Richtbare led en  
zijhandgreep



Werkbereik 90°  
(met uiterste stand 160°  
voor het opbergen)

**DBS180RTJ**

Spanning		18 V
Bijgeleverde accu's		2 x BL1850B
Bandsnelheid		600 - 1700 m/min
Schuurband		9 x 533 mm
Gewicht		1,8 - 2,1 kg
Prijs in €	excl. btw	€ 615,00
	incl. btw	€ 744,15

ACCU MULTITOOL

Wist je dat er van DTM51 de voordelige uitvoeringen DTM51Z en DTM51T1JX2 bestaan? Zie p. 52-53 voor meer info!



STARLOCK



Gereedschapsloze accessoirewissel

DTM51RTJX2

STARLOCK STARLOCK PLUS STARLOCK MAX



DTM52 incl. accessoires

DTM51

- Compatibel met OIS en Starlock (niet met Starlock Plus en Starlock Max).

Inclusief: set van 9 accessoires, 30 schuurvellen, 1 afzuigset

DTM52

- Compatibel met Starlock, Starlock Plus en Starlock Max accessoires, ideaal voor de zwaardere toepassingen.
- Grote oscillatiehoek van 1,8° links/rechts
- Zeer lage trillingswaarden dankzij AVT technologie
- Kleine greepomtrek en laag gewicht

	DTM51RTJX2	DTM52RTJX1
Spanning	18 V	18 V
Bijgeleverde accu's	2 x BL1850B	2 x BL1850B
BL motor	-	✓
Oscillatiefrequentie	6000-20000 /min	10000-20000 /min
Oscillatiehoek	3,2°	3,6°
Opname	OIS, Starlock	Starlock, Starlock Plus, Starlock Max
Gewicht	2,0 kg	1,7 kg
Prijs in €	excl. btw	€ 499,00
	incl. btw	€ 603,79
		€ 529,00
		€ 640,09

STARLOCK



STARLOCK PLUS



STARLOCK MAX



Voor het totaal overzicht van het assortiment scan hier

- ✓ Snelle wissel van accessoires door een simpele klik
- ✓ Starlock Plus zaagbladen : snel, diep en veelzijdig invallend zagen
- ✓ Starlock Max zaagbladen : zelfs voor de meest veeleisende en zware toepassingen

Starlock Plus en Starlock Max accessoires kunnen enkel gebruikt worden met de DTM52.

ACCU SCHUURPOLIJSTMACHINE 75 MM



**Polijsten**  
Steunschijf met velcro opname voor polijst toepassingen.



**Compact**  
Uiterst compacte machine met de handgreep kort bij de schijf voor een optimale controle.

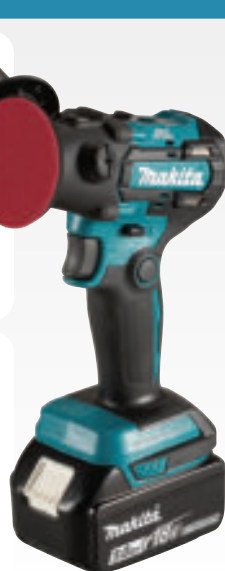

DPV300RTJ

- Zeer compacte machine ideaal voor het schuren en polijsten van kleine oppervlakken.
- Twee mechanische versnellingen en traploze snelheidsregeling.
- Geleverd met velcro steunschijf voor het polijsten en een Roloc™ opname voor schuurtoepassingen.



**Schuren**  
Roloc™ compatibele opname voor schuurtoepassingen.

● Accessoires

Steunschijf

Referentie	Omschrijving	Prijs excl. btw	Prijs incl. btw
E-07412	Schuurschijf aluminiumoxide 50 mm A60 (25 st.)	€ 50,00	€ 60,50
E-07428	Schuurschijf aluminiumoxide 50 mm A80 (25 st.)	€ 50,00	€ 60,50
E-07434	Schuurschijf aluminiumoxide 50 mm A120 (25 st.)	€ 50,00	€ 60,50
E-07440	Schuurschijf zirconium 50 mm Z60 (25 st.)	€ 50,00	€ 60,50
E-07456	Schuurschijf zirconium 50 mm Z80 (25 st.)	€ 50,00	€ 60,50
E-07462	Vliesschijf zirconium Grof / Hard 50 mm (25 st.)	€ 85,70	€ 103,70
E-07478	Vliesschijf zirconium Medium / Hard 50 mm (25 st.)	€ 84,00	€ 101,60
E-07484	Vliesschijf zirconium Fijn / Hard 50 mm (25 st.)	€ 85,70	€ 103,70
E-07490	Vliesschijf zirconium Medium/ Zacht 50 mm (25 st.)	€ 80,60	€ 97,50
E-07509	Vliesschijf zirconium Fijn/Zacht 50 mm (25 st.)	€ 80,60	€ 97,50
E-07515	Vliesschijf zirconium Zeer fijn/ Zacht 50 mm (25 st.)	€ 80,60	€ 97,50

DPV300RTJ

Bijgeleverde accu's	2 x BL1850	
Capaciteit polijsten	80 mm	
Capaciteit schuren	50 mm	
Toerental polijsten	0-2800 min <sup>-1</sup>	
Toerental schuren	0-9500 min <sup>-1</sup>	
Gewicht	1,3 kg	
Prijs in €	excl. btw	€ 519,00
	incl. btw	€ 627,99

ACCU BANDZAGEN

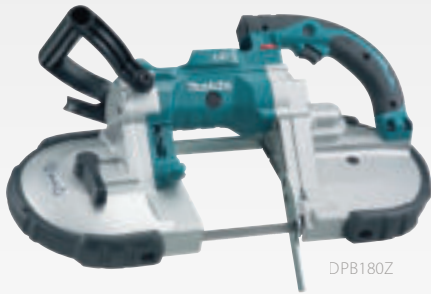

DPB180Z

Aluminium  
behuizing



DPB183Z



DPB184Z

	DPB180Z	DPB184Z	DPB183Z
Spanning	18 V	18 V	18 V
Bijgeleverde accu's	-	-	-
Bijgeleverde lader	-	-	-
Max. bandsnelheid	162 m/min	192 m/min	192 m/min
Capaciteit stalen buis	120 x 120 mm	51 x 51 mm	66 x 66 mm
BL-motor	-	✓	✓
Gewicht	6,8 kg	3,2 kg	3,8 kg
Prijs in €	excl. btw	€ 405,00	€ 315,00
	incl. btw	€ 490,05	€ 381,15
		€ 335,00	€ 405,35

ACCU METAALAFKORTMACHINE



DLW140PG2

Gereedschapsloze (hoek)-  
verstelling van de geleider.

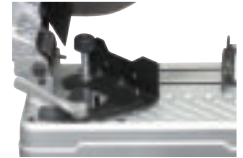

	DLW140Z	DLW140PG2	
Spanning	2 x 18 V	2 x 18 V	
Bijgeleverde accu's	0	2 x BL1860B	
Toerental onbelast	3800 t.p.m.	3800 t.p.m.	
Diameter schijf	355 mm	355 mm	
Gewicht	16,9 kg	16,9 kg	
Prijs in €	excl. btw	€ 425,00	€ 689,00
	incl. btw	€ 514,25	€ 833,69

ACCU BLINDKLINKNAGELPISTOLEN



DRV150Z



Scan deze code  
voor uitgebreide  
technische info.

	DRV150Z	DRV250Z	
Bijgeleverde accu's/lader	-	-	
Trekkracht	10 kN	20 kN	
Compatibel met blindklinknagel Ø	24 / 32 / 40 / 48 mm	48 / 60 / 64 mm	
Slaglengthe	25 mm	30 mm	
Gewicht	1,9 kg	2,1 kg	
Prijs in €	excl. btw	€ 829,00	€ 829,00
	incl. btw	€ 1.003,09	€ 1.003,09

ACCU AFKORTSLIJPMACHINES

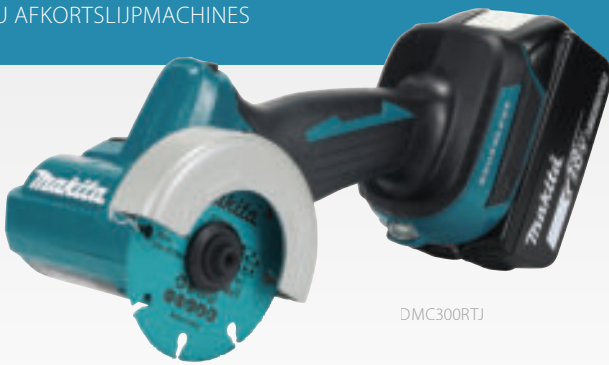

DMC300RTJ

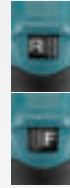

DMC300

- Zeer compacte slijpmachine, ideaal voor het zagen op moeilijk bereikbare plaatsen
- Goed uitgebalanceerd, kan veilig met één hand gebruikt worden
- De draairichting is omkeerbaar
- Stofkap met aansluiting voor stofafzuiging standaard bijgeleverd
- Voor het zagen in staal, keramiek en kunststoffen



D-74815-5 D-77263 D-74837

Accessoires

Ref	Type	Prijs excl. btw	Prijs incl. btw
D-74815-5	Doorslijpschijf voor RVS 76mm (5 stuks)	€ 4,90	€ 5,93
D-77263	Diamantschijf 76x1,4x10mm	€ 8,50	€ 10,29
D-74837	Carbide multi-snijschijf 76x10mm	€ 8,50	€ 10,29

NIEUW

DMC300ZJ

NIEUW

DMC300RTJ

Spanning	18 V	18 V
Bijgeleverde accu's	-	2x BL1850B
Lader	-	DC18RC
Ø schijf	76 mm	76 mm
Toerental onbelast	20000 min <sup>-1</sup>	20000 min <sup>-1</sup>
Max. zaagdiepte	met stofkap: 13,5 mm zonder stofkap: 16,0 mm	met stofkap: 13,5 mm zonder stofkap: 16,0 mm
Gewicht	1,2 - 1,7 kg	1,2 - 1,7 kg
Prijs in €	excl. btw	€ 159,00
	incl. btw	€ 192,39
Prijs in €	excl. btw	€ 389,00
	incl. btw	€ 470,69

ACCU DOORSLIJPER



DCE090T2X1

Maximale zaagdiepte 88 mm

Promo  
DCE090ZK1 en DCE090T2X1:  
gratis 25 doorslijpschijven RVS



Accessoires

Ref	Type	Prijs excl. btw	Prijs incl. btw
E-03006-25	Doorslijpschijf RVS (25 st.) 230 x 2,0 x 22,23 mm	€ 80,60	€ 97,53
E-02967	Diamantschijf 230 mm x 2,4 x 22,23 mm	€ 169,30	€ 204,85

De gesegmenteerde diamantschijf E-02967 werd speciaal ontwikkeld voor het gebruik met een accu doorslijper. De diamantkorrels zijn gelijkmatig verdeeld en volgens een speciaal V-vormig patroon ingebed. Daardoor blijft de schijf continu scherp en zijn de zaagprestaties optimaal.



	DCE090ZK1	DCE090T2X1
Spanning	2 x 18 V	2 x 18 V
Bijgeleverde accu's	0	2 x BL1850B
Lader	-	DC18RD
Ø schijf	230 mm	230 mm
Toerental onbelast	6600 min <sup>-1</sup>	6600 min <sup>-1</sup>
Max. zaagdiepte	88 mm	88 mm
Max. schijfdikte	3,0 mm	3,0 mm
Gewicht	5,6 - 6,3 kg	5,6 - 6,3 kg
Prijs in €	excl. btw	€ 549,00
	incl. btw	€ 664,29
Prijs in €	excl. btw	€ 809,00
	incl. btw	€ 978,89

ACCU DIAMANTZAAG 125 MM



Inclusief 2 stofkappen, voor droog en nat gebruik

Ideaal voor afwerking (steen, beton, keramiek)

Kantelbaar tot 45°

	DCC501RTJ	
Spanning	18 V	
Toerental onbelast	8500 min <sup>-1</sup>	
AWS	✓ excl. Bluetooth unit	
Diameter asgat	20 mm	
Bijgeleverde accu's	2 x BL1850B	
Gewicht	2,7 kg	
Prijs in €	excl. btw	€ 525,00
	incl. btw	€ 635,25

ACCU HAAKSE SLIJERS 125 MM

**ADT AFT** **BL MOTOR**

Wist je dat er van DGA506 en DGA508 de voordelige uitvoeringen DGA506Z / DGA506T1J en DGA508Z / DGA508T1J bestaan? Zie p. 52-53 voor meer info!

Promo  
DGA506T1J en DGA508T1J:  
gratis 10 doorslijpschijven  
D-18770-10

**18V LITHIUM-ION** **MAX PAC**

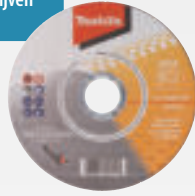

Promo  
DGA506RTJ en DGA508RTJ:  
gratis extra accu BL1830B

	DGA506RTJ	DGA508RTJ	DGA513RTJ	DGA514RTJU	DGA517RTJ	DGA518RTJU	
Spanning	18V	18V	18V	18V	18V	18V	
Bijgeleverde accu's	2 x BL1850B	2 x BL1850B	2 x BL1850B	2 x BL1850B	2 x BL1850B	2 x BL1850B	
Ø schijf	125 mm	125 mm	125 mm	125 mm	125 mm	125 mm	
Heropstartbeveiliging	✓	✓	✓	✓	✓	✓	
Elektrische rem	✓	✓	✓	✓	✓	✓	
Regelbaar toerental	-	-	✓	✓	✓	✓	
AWS	-	-	-	✓	-	✓	
Schakelaar	Schuifschakelaar met vergrendeling	Lepeschakelaar, zonder vergrendeling	Schuifschakelaar met vergrendeling	Schuifschakelaar met vergrendeling	Lepeschakelaar, zonder vergrendeling	Lepeschakelaar, zonder vergrendeling	
Gewicht	2,5 kg	2,5 kg	2,5 kg	2,5 kg	2,5 kg	2,5 kg	
Prijs in €	excl. btw	€ 459,00	€ 455,00	€ 489,00	€ 529,00	€ 489,00	€ 529,00
	incl. btw	€ 555,39	€ 550,55	€ 591,69	€ 640,09	€ 591,69	€ 640,09

BESCHERMKAP MET STOFAFZUIGING VOOR HAAKSE SLIJERS



	196845-3	198440-5	
Diameter stofkap	125 mm	230 mm	
Max. zaagdiepte	20 mm	60 mm	
Prijs in €	excl. btw	€ 84,70	€ 152,40
	incl. btw	€ 102,50	€ 184,40

ACCU STEPELSLIJPER



**DGD800RTJ**

Spanning	18V	
Bijgeleverde accu's	2 x BL1850B	
Toerental	25000 t.p.m.	
Ø spantang - bereik	6 - 8 mm	
Ø spantang - inbegrepen	6 mm	
Gewicht	2,1 kg	
Prijs in €	excl. btw	€ 449,00
	incl. btw	€ 543,29

ACCU HAAKSE SLIJERS 180-230 MM

**ADT AFT** **18V + 18V** **36V**



DGA900PG2

DGA701ZKU

	DGA701ZKU	DGA900ZK	DGA900PG2	DGA901ZKU	DGA901PG2U	
Spanning	2 x 18V	2 x 18V	2 x 18V	2 x 18V	2 x 18V	
Bijgeleverde accu's	0	0	2 x BL1860B	0	2 x BL1860B	
Ø schijf	180 mm	230 mm	230 mm	230 mm	230 mm	
AWS	✓	-	-	✓	✓	
Gewicht	5,0 kg	5,2 kg	5,2 kg	5,2 kg	5,2 kg	
Prijs in €	excl. btw	€ 349,00	€ 325,00	€ 609,00	€ 365,00	€ 649,00
	incl. btw	€ 422,29	€ 393,25	€ 736,89	€ 441,65	€ 785,29

ACCU HAAKSE SLIJPER 125 MM X-LOCK



DGA519RTJ

DGA521ZX1



Snel en veilig schijven bevestigen via een kliksysteem.



ACCESSOIRES X-LOCK

Referentie	Type	Prijs excl. btw	Prijs incl. btw
E-00393	Afbraamschijf voor metaal 125 mm x 6 x 22,23	€ 3,70	€ 4,50
E-00402	Afbraamschijf voor inox 125 mm x 6 x 22,23	€ 4,10	€ 5,00
E-00418	Doorslijpschijf voor inox 125 mm x 1,2 x 22,23	€ 3,00	€ 3,60
E-02076	Diamantdoorslijpschijf 125 mm	€ 38,60	€ 46,70
191G05-4	Beschermkap met stofafzuiging 125 mm	€ 99,20	€ 120,00
D-73396	Komborstel voor metaal, gegolfde draad 75 mm x 0,3	€ 14,10	€ 17,10
D-73433	Komborstel voor metaal, gegolfde draad, vermessingd 75 mm x 0,3	€ 14,10	€ 17,10
D-73346	Komborstel voor inox, gegolfde draad 75 mm x 0,3	€ 20,80	€ 25,20
D-73374	Komborstel voor metaal, getordeerde draad 80 mm x 0,35	€ 15,60	€ 18,90
D-73380	Komborstel voor metaal, getordeerde draad 80 mm x 0,5	€ 15,60	€ 18,90
D-73330	Komborstel voor inox, getordeerde draad 80 mm x 0,5	€ 25,00	€ 30,30
D-73449	Kegelborstel voor metaal, gegolfde draad 100 mm x 0,3	€ 17,20	€ 20,80
D-73411	Schijfborstel voor metaal, getordeerde draad 115 mm x 0,5	€ 21,90	€ 26,50
D-73427	Schijfborstel voor metaal, gegolfde draad 115 mm x 0,3	€ 19,80	€ 24,00
E-11776	Doorslijpschijf TCG 125 mm x 2 x 22,23 X-Lock	€ 22,50	€ 27,20
<b>NIEUW</b> E-19738	Vacuüm gesoldeerde diamantschijf 125 mm	€ 67,50	€ 81,68

	DGA521ZX1	DGA520ZX1	DGA519ZJ	DGA519RTJ
Spanning	18 V	18 V	18 V	18 V
Bijgeleverde accu's	0	0	0	2 x BL1850B
Ø schijf	125 mm	125 mm	125 mm	125 mm
Toerental onbelast	8500 min <sup>-1</sup>	8500 min <sup>-1</sup>	3000 - 8500 t.p.m.	3000 - 8500 t.p.m.
Heropstartbeveiliging	✓	✓	✓	✓
Elektrische rem	-	✓	✓	✓
Regelbaar toerental	-	-	✓	✓
Type schakelaar	Schuifschakelaar met vergrendeling	Lepelschakelaar zonder vergrendeling	Lepelschakelaar zonder vergrendeling	Lepelschakelaar zonder vergrendeling
Gewicht	2,4 - 3,0 kg	2,4 - 3,0 kg	2,5 kg	2,5 kg
Prijs in €	excl. btw	€ 209,00	€ 229,00	€ 269,00
	incl. btw	€ 252,89	€ 277,09	€ 325,49

ACCU KNABBELSCHAAR



DJN161RTJ

Spanning	18 V	
Bijgeleverde accu's	2 x BL1850B	
Max. aantal snijbewegingen	1900 min <sup>-1</sup>	
Max. dikte staal	1,6 mm	
Gewicht	2,2 kg	
Prijs in €	excl. btw	€ 699,00
	incl. btw	€ 845,79

ACCU PLAATSCHAREN



DJS130ZJ

DJS131Z

DJS200Z

DJS800Z

bij alle modellen kan de kop 360° gedraaid worden

DJS131: kan bochten en gegolfde staalplaat snijden

DJS200: voor het knippen van rechte stukken met minimale vervorming



DJS800

- Geschikt voor het knippen van o.a. cementbeplating, brandwerende platen en geluidsisolatieplaten tot 13 mm dikte.
- Knipt vrijwel stofvrij, snel en zonder lawaai.
- De snijkop is 360° draaibaar voor knippen op moeilijk bereikbare plaatsen.

	DJS130ZJ	DJS200Z	DJS131Z	DJS800Z
Spanning	18 V	18 V	18 V	18 V
Bijgeleverde accu's	-	-	-	-
BL-motor	-	✓	✓	✓
Aantal zaagbewegingen	2800 min <sup>-1</sup>	0-3000 min <sup>-1</sup>	0-3000 min <sup>-1</sup>	0-3000 min <sup>-1</sup>
Max. dikte staal	1,3 mm	2,0 mm	1,3 mm	13 mm (vezelcement)
Gewicht	2,3 - 2,6 kg	2,2 - 2,5 kg	2,0 - 2,3 kg	2,1 - 2,5 kg
Prijs in €	excl. btw	€ 375,00	€ 425,00	€ 519,00
	incl. btw	€ 453,75	€ 514,25	€ 627,99

ACCU VLECHTMACHINE



DTR180ZJ



DTR181ZJ

**DTR181**

- Deze versie kan grotere verbindingen maken, tot bijvoorbeeld: (2 x 16 mm) + (2 x 13 mm) of 25 mm + 22 mm.

Promo  
DTR180ZJ :  
gratis doos gegalvaniseerde  
binddraad 191A57-9

Optioneel accessoire:  
handgreep 191M27-0  
€ 199,00 excl. btw  
€ 240,80 incl. btw



		DTR180ZJ	DTR181ZJ
Spanning		18 V / 14,4 V	18 V / 14,4 V
Bijgeleverde accu's		0	0
Vlechtcapaciteit		10 mm + 10 mm (2 x 13 mm) + (2 x 13 mm)	16 mm + 16 mm (2 x 16 mm) + (2 x 13 mm)
Draaddikte		0,8 mm	0,8 mm
Modus		Enkelvoudig/continu	Enkelvoudig/continu
Gewicht		2,3 kg	2,3 kg
Prijs in €	excl. btw	€ 979,00	€ 1.019,00
	incl. btw	€ 1.184,59	€ 1.232,99



Polyester draad: 191J59-9  
(100 m, Ø 0,8 mm) 50 stuks/doos  
€ 305,80 excl. btw  
€ 370,00 incl. btw



Vlechtdraad gegalvaniseerd: 191A57-9  
(100 m, Ø 0,8 mm) 50 stuks/doos  
€ 247,10 excl. btw  
€ 299,00 incl. btw



Vlechtdraad staal: 199137-9  
(100 m, Ø 0,8 mm) 50 stuks/doos  
€ 210,80 excl. btw  
€ 255,10 incl. btw

ACCU VACUÛMPOMP



**DVP181**

- Kan continu werken dankzij twee accu's in parallel
- Tweetraps pomp met hoog debiet



DVP181ZK



DVP180Z

		DVP180Z	DVP181ZK
Spanning		18 V	18 V, 2 accu's in parallel
Bijgeleverde accu/lader		-	-
Compressor		ééntraps olieafgedichte schottenpomp	Tweetraps olieafgedichte schottenpomp
Debiet		60 l/min	113 l/min
Eindvacuüm		20 Pa (150 micron)	3 Pa (22,5 micron)
Gewicht		2,9 kg	8,2 kg
Prijs in €	excl. btw	€ 355,00	€ 799,00
	incl. btw	€ 429,55	€ 966,79

ACCU KITPISTOOL



INCLUSIEF  
kokerhouder  
600 ml bij  
DCG180RAX



DCG180RA  
300 ml

DCG180RAX

		DCG180RA	DCG180RAX
Spanning		18 V	18 V
Bijgeleverde accu's		1 x BL1820B	1 x BL1820B
Max. spuitdruk		5000 N	5000 N
Max. extrusiesnelheid		0-28 mm/s	0-28 mm/s
Gewicht		2,1 kg	2,4 kg
Prijs in €	excl. btw	€ 379,00	€ 425,00
	incl. btw	€ 458,59	€ 514,25



Voor gebruiksklaar afkorten zonder vonken

Mobiel afkorten



DSC102ZJ



DSC121ZK

Stationair afkorten



DSC102

	DSC102ZJ	DSC121ZK
Spanning	18 V	18 V
Bijgeleverde accu's	0	0
Snijcapaciteit	M6/M8/M10	M8/M10/M12
Inbegrepen messenset	M8/M10	M8
Gewicht	3,3 kg	5,7 kg
Prijs in €	excl. btw	€ 639,00
	incl. btw	€ 773,19
		€ 1.779,00
		€ 2.152,59



DSC251ZK

Spanning	18 V	
Bijgeleverde accu's/lader	0	
Snijcapaciteit	10-25 mm	
Gewicht	3,9 kg	
Prijs in €	excl. btw	€ 1.069,00
	incl. btw	€ 1.293,49



DSC163ZK

DSC163ZK DSC191Z

Spanning	18 V	18 V
Bijgeleverde accu's/lader	-	-
Snijcapaciteit	3 - 16 mm	3 - 20 mm
BL-motor	✓	-
Gewicht	6,9 kg	11,1 - 11,2 kg
Prijs in €	excl. btw	€ 1.989,00
	incl. btw	€ 2.406,69
		€ 2.189,00
		€ 2.648,69



DPP200ZK

Spanning	18 V	
Max. diameter ponsgat	20 mm	
Inbegrepen Ø	12 mm	
Max. dikte staal	8 mm	
Max. dikte inox	6 mm	
Gewicht	10,5 kg	
Prijs in €	excl. btw	€ 2.349,00
	incl. btw	€ 2.842,29

Werkt met standaard 400 g patronen of vet in bulk



Debietregeling: automatisch of traag (met hoogste druk)



DGP180RT

Hogedrukslang van 120 cm



DGP180RT

		DGP180Z	DGP180RT
Spanning		18V	18V
Bijgeleverde accu's		-	1 x BL1850B
Maximale druk		690 bar	690 bar
Debiet		145-290 ml/min	145-290 ml/min
Gewicht		4,8 kg	4,8 kg
Prijs in €	excl. btw	€ 305,00	€ 469,00
	incl. btw	€ 369,05	€ 567,49



DVR850Z



- Voeding middels PDC01/ PDC1200 draagbaar accupack (accupack niet inbegrepen)
- Zeer comfortabel werken omdat enkel de trilnaald gehanteerd moet worden.
- Compatibel met flessen met grote diameter Ø 43 mm en Ø 52 mm
- Werktijd tot 300 minuten met PDC1200



VR004C



VR001C

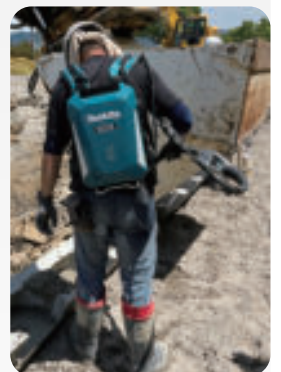

		DVR350Z	DVR450Z	DVR850Z
Spanning		18V	18V	18V
Bijgeleverde accu's		0	0	0
Lengte trilnaald		80 cm	120 cm	240 cm
Diameter trilnaald		25 mm	25 mm	25 mm
Gewicht		2,0 kg	2,3 kg	2,4 kg
Prijs in €	excl. btw	€ 325,00	€ 355,00	€ 465,00
	incl. btw	€ 393,25	€ 429,55	€ 562,65

		VR001CZ	VR002CZ	VR003CZ	VR004CZ
Spanning		36V (Direct connect)	36V (Direct connect)	36V (Direct connect)	36V (Direct connect)
Bijgeleverde accu's		-	-	-	-
Trilfrequentie		1200 min <sup>-1</sup>	1200 min <sup>-1</sup>	1200 min <sup>-1</sup>	1200 min <sup>-1</sup>
Ø triffles		43 mm	43 mm	52 mm	52 mm
Lengte trilnaald		1,5 m	3,0 m	1,5 m	3,0 m
Autonomie (PDC1200)		300 min	300 min	200 min	200 min
Gewicht		11,8 kg	12,9 kg	12,6 kg	13,7 kg
Prijs in €	excl. btw	€ 2.099,00	€ 2.299,00	€ 2.199,00	€ 2.399,00
	incl. btw	€ 2.539,79	€ 2.781,79	€ 2.660,79	€ 2.902,79

# BESPAAR MET ONZE COMBOPACKS

**PROMO**

Gratis extra BL1830B bij al deze combopacks

MACHINES IN COMBOPACK 18 V		MACHINES 2 x 18 V	ACCU	DC18RC	MAK-PAC	PRIJS IN €
			3 x  BL1850B			€ 509,00 excl. btw € 615,89 Incl. btw
			3 x  BL1850B			€ 569,00 excl. btw € 688,49 incl. btw
			2 x  BL1850B			€ 739,00 excl. btw € 894,19 Incl. btw
			3 x  BL1850B			€ 589,00 excl. btw € 712,69 Incl. btw
			3 x  BL1850B		2 x 	€ 609,00 excl. btw € 736,89 Incl. btw
			3 x  BL1850B			€ 689,00 excl. btw € 833,69 Incl. btw
			4 x  BL1850B		3 x 	€ 875,00 excl. btw € 1.058,75 incl. btw
			3 x  BL1850B			€ 739,00 excl. btw € 894,19 incl. btw

DLX2289T3J

DLX2189T3J

DLX2440TJ

DLX2236TJ1

DLX2235T3J

DLX2434TJ

DLX2194PTJ

DLX2245PT1

**PROMO**

Gratis extra BL1830B bij combopacks op deze pagina





# BESPAAR MET ONZE COMBOPACKS

	DHP486	DTD153	DHR243	DGA506	DHS680	DJV181	DTM51
DLX2418TJ							
DLX4159TJ							
DLX5093TJ							
DLX5071TJ							
DLX6128JX1							
DLX1055JX1							
DLX1122JX1							

## PROMO batterij BL1850B meteen geleverd in Makpac

Combineer voordelig  
met deze aanbieding

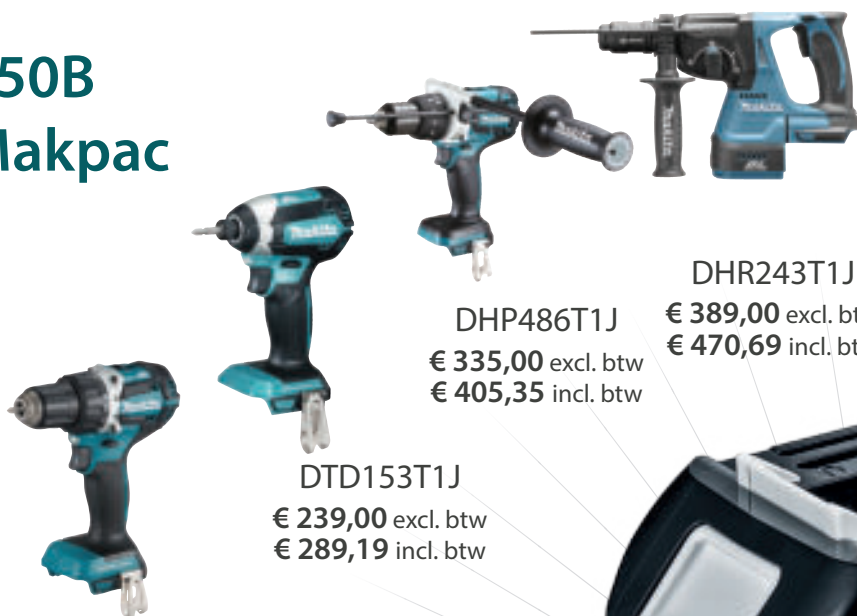

DHR243T1J  
€ 389,00 excl. btw  
€ 470,69 incl. btw

DHP486T1J  
€ 335,00 excl. btw  
€ 405,35 incl. btw

DTD153T1J  
€ 239,00 excl. btw  
€ 289,19 incl. btw

DDF484T1J  
€ 245,00 excl. btw  
€ 296,45 incl. btw

DTM51T1JX2  
€ 345,00 excl. btw  
€ 417,45 incl. btw





**TR0000001**

TROLLEY

€ 149,00 excl. btw

€ 180,29 incl. btw



DJR188Z	DRT50JX3	DBO180ZJ	DDA351ZJ	BL1850B 18V 5,0 Ah	DC18RC	KOFFER	PROMO	PRIJS IN €
				3 x 			<b>PROMO</b>  BL1830B	€ 629,00 excl. btw € 761,09 incl. btw
				3 x 		2 x 	<b>PROMO</b>  BL1830B	€ 1.119,00 excl. btw € 1.353,99 incl. btw
				3 x 		3 x 	<b>PROMO</b>  BL1830B	€ 1.269,00 excl. btw € 1.535,49 incl. btw
				3 x 		3 x 	<b>PROMO</b>  BL1830B	€ 1.249,00 excl. btw € 1.511,29 incl. btw
				3 x 		4 x 	<b>PROMO</b>  3x BL1830B	€ 1.529,00 excl. btw € 1.850,09 incl. btw
				5 x 	2 x 	9 x 	<b>PROMO</b>  3x BL1830B	€ 2.425,00 excl. btw € 2.934,25 incl. btw
				5 x 	2 x 	10 x 	<b>PROMO</b>  3x BL1830B	€ 2.649,00 excl. btw € 3.205,29 incl. btw



DHS680T1J

€ 345,00 excl. btw  
€ 417,45 incl. btw



DTW300T1J

€ 329,00 excl. btw  
€ 398,09 incl. btw



DJV181T1J

€ 325,00 excl. btw  
€ 393,25 incl. btw



DJV182T1J

€ 325,00 excl. btw  
€ 393,25 incl. btw

DGA506T1J

€ 279,00 excl. btw  
€ 337,59 incl. btw



DGA508T1J

€ 285,00 excl. btw  
€ 344,85 incl. btw



Deze modellen bestaan ook in een voordelige 'Z-versie' zonder accu, lader, Makpac of andere extra toebehoren.



# HET **LXT** -PLATFORM

## DBN500ZJ

Minibradpistool 18 V

Prijs excl. BTW € 475,00  
Prijs incl. BTW € 574,75 Makpac



## DBN600ZJ

Bradpistool 18 V

Prijs excl. BTW € 489,00  
Prijs incl. BTW € 591,69 Makpac



## DBO180ZJ

Excentrische schuurmachine 18 V

Prijs excl. BTW € 159,00  
Prijs incl. BTW € 192,39 Makpac



## DBO380ZJ

Vlakschuurmachine 18 V

Prijs excl. BTW € 175,00  
Prijs incl. BTW € 211,75 Makpac



## DBO381ZJU

Vlakschuurmachine 18 V

Prijs excl. BTW € 199,00  
Prijs incl. BTW € 240,79 Makpac



## DBO480ZJ

Vlakschuurmachine 18 V

Prijs excl. BTW € 139,00  
Prijs incl. BTW € 168,19 Makpac



## DBO481ZJ

Vlakschuurmachine 18 V

Prijs excl. BTW € 119,00  
Prijs incl. BTW € 143,99 Makpac



## DBO482ZJ

Vlakschuurmachine 18 V

Prijs excl. BTW € 129,00  
Prijs incl. BTW € 156,09 Makpac



## DBS180ZJ

Bandschuurmachine 9 mm 18 V

Prijs excl. BTW € 369,00  
Prijs incl. BTW € 446,49 Makpac



## DCB200B

Verwarmd deken 18 V

Prijs excl. BTW € 139,00  
Prijs incl. BTW € 168,19 Karton



## DCC501ZJ

Diamantzaag 125 mm 18 V

Prijs excl. BTW € 275,00  
Prijs incl. BTW € 332,75 Makpac



## DCG180ZK

Kitpistool 18 V

Prijs excl. BTW € 249,00  
Prijs incl. BTW € 301,29 Koffer



## DCG180ZXK

Kitpistool 18 V incl. kokerhouder

Prijs excl. BTW € 285,00  
Prijs incl. BTW € 344,85 Koffer



## DCO181Z

Gipsfrees 18 V

Prijs excl. BTW € 225,00  
Prijs incl. BTW € 272,25 Karton



## DCS552ZJ

Metaalcirkelzaag 18 V

Prijs excl. BTW € 245,00  
Prijs incl. BTW € 296,45 Makpac



## DCS553ZJ

Metaalcirkelzaag 18 V

Prijs excl. BTW € 315,00  
Prijs incl. BTW € 381,15 Makpac



## DDA351ZJ

Haakse boormachine 18 V

Prijs excl. BTW € 229,00  
Prijs incl. BTW € 277,09 Makpac



## DDA450ZK

Haakse boormachine 18 V

Prijs excl. BTW € 319,00  
Prijs incl. BTW € 385,99 Koffer



## DDF083ZJ

Boor- en schroefmachine 1/4" 18 V

Prijs excl. BTW € 149,00  
Prijs incl. BTW € 180,29 Makpac



## DDF482ZJ

Boor- en schroefmachine 18 V

Prijs excl. BTW € 129,00  
Prijs incl. BTW € 156,09 Makpac



## DDF484Z

Boor- en schroefmachine 18 V

Prijs excl. BTW € 129,00  
Prijs incl. BTW € 156,09 Karton



## DDF489ZJ

Boor- en schroefmachine 18 V

Prijs excl. BTW € 189,00  
Prijs incl. BTW € 228,69 Makpac **NIEUW**



## DDF486ZJ

Boor- en schroefmachine 18 V

Prijs excl. BTW € 225,00  
Prijs incl. BTW € 272,25 Makpac



## DFN350ZJ

Minibradpistool 18 V

Prijs excl. BTW € 415,00  
Prijs incl. BTW € 502,15 Makpac



## DFR452ZJ

Schroefautomaat 18 V

Prijs excl. BTW € 375,00  
Prijs incl. BTW € 453,75 Makpac



## DFR550ZJ

Schroefautomaat 18 V

Prijs excl. BTW € 399,00  
Prijs incl. BTW € 361,79 Makpac



## DFR551ZJ

Schroefautomaat 18 V

Prijs excl. BTW € 399,00  
Prijs incl. BTW € 470,69 Makpac



## DFR750Z

Schroefautomaat 18 V

Prijs excl. BTW € 299,00  
Prijs incl. BTW € 361,79 Karton



## DFS250ZJ

Schroefmachine 18 V

Prijs excl. BTW € 209,00  
Prijs incl. BTW € 252,89 Makpac



## DFS452ZJ

Schroefmachine 18 V

Prijs excl. BTW € 239,00  
Prijs incl. BTW € 289,19 Makpac



## DGA506Z

Haakse slijper 125 mm 18 V

Prijs excl. BTW € 165,00  
Prijs incl. BTW € 199,65 Karton



## DGA508Z

Haakse slijper 125 mm 18 V

Prijs excl. BTW € 195,00  
Prijs incl. BTW € 235,95 Karton



## DGA513ZJ

Haakse slijper 125 mm 18 V

Prijs excl. BTW € 239,00  
Prijs incl. BTW € 289,19 Makpac



## DGA514ZJU

Haakse slijper 125 mm 18 V

Prijs excl. BTW € 279,00  
Prijs incl. BTW € 337,59 Makpac



## DGA517ZJ

Haakse slijper 125 mm 18 V

Prijs excl. BTW € 239,00  
Prijs incl. BTW € 289,19 Makpac



## DGA518ZJU

Haakse slijper 125 mm 18 V

Prijs excl. BTW € 279,00  
Prijs incl. BTW € 337,59 Makpac



## DGA519ZJ

Haakse slijper 125 mm X-lock 18 V

Prijs excl. BTW € 269,00  
Prijs incl. BTW € 325,49 Makpac



## DGA520ZX1

Haakse slijper 125 mm X-lock 18 V

Prijs excl. BTW € 229,00  
Prijs incl. BTW € 277,09 Karton



## DGA521ZX1

Haakse slijper 125 mm X-lock 18 V

Prijs excl. BTW € 209,00  
Prijs incl. BTW € 252,89 Karton



## DGD800ZJ

Stempelslijper 18 V

Prijs excl. BTW € 199,00  
Prijs incl. BTW € 240,79 Makpac



## DGP180Z

Vetpomp 18 V

Prijs excl. BTW € 305,00  
Prijs incl. BTW € 369,05 Karton



## DHG180ZJ

Heteluchtpistool 18 V

Prijs excl. BTW € 155,00  
Prijs incl. BTW € 187,55 Makpac



## DHG181ZJ

Heteluchtpistool 18 V

Prijs excl. BTW € 175,00  
Prijs incl. BTW € 211,75 Makpac



## DHP484ZJ

Klopboor- en schroefmachine 18 V

Prijs excl. BTW € 169,00  
Prijs incl. BTW € 204,49 Makpac



## DHP489ZJ

Klopboor- en schroefmachine 18 V

Prijs excl. BTW € 205,00  
Prijs incl. BTW € 248,05 Makpac **NIEUW**



## DHP486Z

Klopboor- en schroefmachine 18 V

Prijs excl. BTW € 235,00  
Prijs incl. BTW € 284,35 Karton



## DHR171ZJ

SDS-PLUS Boorhamer 18 V

Prijs excl. BTW € 215,00  
Prijs incl. BTW € 260,15 Makpac



## DHR182ZJ

SDS-PLUS Boorhamer 18 V

Prijs excl. BTW € 265,00  
Prijs incl. BTW € 320,65 Makpac



## DHR182ZWJ

SDS-PLUS Boorhamer 18 V

Prijs excl. BTW € 305,00  
Prijs incl. BTW € 369,05 Makpac



## DHR183ZJ

SDS-PLUS Boorhamer 18 V

Prijs excl. BTW € 245,00  
Prijs incl. BTW € 296,45 Makpac



## DHR202ZJ

SDS-PLUS Boorhamer 18 V

Prijs excl. BTW € 229,00  
Prijs incl. BTW € 277,09 Makpac



## DHR243Z

SDS-PLUS Boorhamer 18 V

Prijs excl. BTW € 279,00  
Prijs incl. BTW € 337,59 Karton



**DHR243ZJW**

SDS-PLUS Boorhamer 18 V + DX07

Prijs excl. BTW  
**€ 395,00**Prijs incl. BTW  
**€ 477,95**

Makpac

**DHR264ZJ**

Combihamer SDS+ 2 x 18 V

Prijs excl. BTW  
**€ 355,00**Prijs incl. BTW  
**€ 429,55**

Makpac

**DHS630ZJ**

Cirkelzaag 165 mm 18 V

Prijs excl. BTW  
**€ 325,00**Prijs incl. BTW  
**€ 393,25**

Makpac

**DHS660ZJ**

Cirkelzaag 165 mm 18 V

Prijs excl. BTW  
**€ 295,00**Prijs incl. BTW  
**€ 356,95**

Makpac

**DHS661ZJU**

Cirkelzaag 165 mm 18 V

Prijs excl. BTW  
**€ 335,00**Prijs incl. BTW  
**€ 405,35**

Makpac

**DHS680Z**

Cirkelzaag 165 mm 18 V

Prijs excl. BTW  
**€ 245,00**Prijs incl. BTW  
**€ 296,45**

Karton

**DHS710ZJ**

Cirkelzaag 190 mm 2 x 18 V

Prijs excl. BTW  
**€ 329,00**Prijs incl. BTW  
**€ 398,09**

Makpac

**DHS782ZJ**

Cirkelzaag 190 mm 2 x 18 V

Prijs excl. BTW  
**€ 415,00**Prijs incl. BTW  
**€ 502,15**

Makpac

**DHS783ZJU**

Cirkelzaag 190 mm 2 x 18 V

Prijs excl. BTW  
**€ 455,00**Prijs incl. BTW  
**€ 550,55**

Makpac

**DHS900Z**

Cirkelzaag 235 mm 2 x 18 V

Prijs excl. BTW  
**€ 479,00**Prijs incl. BTW  
**€ 579,59**

Karton

**DHS900ZU**

Cirkelzaag 235 mm 2 x 18 V

Prijs excl. BTW  
**€ 519,00**Prijs incl. BTW  
**€ 627,99**

Karton

**DJN161ZJ**

Knabberschaar 18 V

Prijs excl. BTW  
**€ 435,00**Prijs incl. BTW  
**€ 526,35**

Makpac

**DJR183ZJ**

Reciprozaag 18 V

Prijs excl. BTW  
**€ 139,00**Prijs incl. BTW  
**€ 168,19**

Makpac

**DJR186ZK**

Reciprozaag 18 V

Prijs excl. BTW  
**€ 179,00**Prijs incl. BTW  
**€ 216,59**

Koffer

**DJR187ZK**

Reciprozaag 18 V

Prijs excl. BTW  
**€ 245,00**Prijs incl. BTW  
**€ 296,45**

Koffer

**DJR188ZJ**

Reciprozaag 18 V

Prijs excl. BTW  
**€ 229,00**Prijs incl. BTW  
**€ 277,09**

Makpac

**DJR189ZJ**

Reciprozaag 18 V

Prijs excl. BTW  
**€ 215,00**Prijs incl. BTW  
**€ 260,15**

Makpac

**DJR360ZK**

Reciprozaag 2 x 18 V

Prijs excl. BTW  
**€ 279,00**Prijs incl. BTW  
**€ 337,59**

Koffer

**DCV202ZL**

Bodywarmer 18 V (maat: L)

Prijs excl. BTW  
**€ 185,00**Prijs incl. BTW  
**€ 223,85**

Makpac

**DCJ205ZL**

Verwarmde jas 18 V (maat: L)

Prijs excl. BTW  
**€ 215,00**Prijs incl. BTW  
**€ 260,15**

Karton

**DCJ206ZXL**

Verwarmde jas 18 V (maat: XL)

Prijs excl. BTW  
**€ 245,00**Prijs incl. BTW  
**€ 296,45**

Karton

**DJV181Z**

Decoupeerzaag 18 V

Prijs excl. BTW  
**€ 245,00**Prijs incl. BTW  
**€ 296,45**

Karton

**DJV182Z**

Decoupeerzaag 18 V

Prijs excl. BTW  
**€ 245,00**Prijs incl. BTW  
**€ 296,45**

Karton

**DJV184Z**

Decoupeerzaag 18 V

Prijs excl. BTW  
**€ 185,00**Prijs incl. BTW  
**€ 223,85**

Karton

**DJV185Z**

Decoupeerzaag 18 V

Prijs excl. BTW  
**€ 185,00**Prijs incl. BTW  
**€ 223,85**

Karton

**NIEUW****DKP181ZU**

Schaaf 18 V

Prijs excl. BTW  
**€ 359,00**Prijs incl. BTW  
**€ 434,39**

Karton

**DLS600Z**

Afkort-verstekzaag 165 mm 18 V

Prijs excl. BTW  
**€ 649,00**Prijs incl. BTW  
**€ 785,29**

Karton

**DPJ180ZJ**

Lamellenfrees 18 V

Prijs excl. BTW  
**€ 259,00**Prijs incl. BTW  
**€ 313,39**

Makpac

**DPT353ZJ**

Pinpistool 18 V

Prijs excl. BTW  
**€ 375,00**Prijs incl. BTW  
**€ 453,75**

Makpac

**DPV300ZJ**Schuur- en polijst-  
machine 75 mm 18 VPrijs excl. BTW  
**€ 275,00**Prijs incl. BTW  
**€ 332,75**

Makpac

**DRT50ZJ**Boven- en  
kantenfrees 18 VPrijs excl. BTW  
**€ 209,00**Prijs incl. BTW  
**€ 252,89**

Makpac

**DRV150ZJ**Blindklinknagel-  
pistool 18 VPrijs excl. BTW  
**€ 829,00**Prijs incl. BTW  
**€ 1.003,09**

Makpac

**DRV250ZJ**Blindklinknagel-  
pistool 18 VPrijs excl. BTW  
**€ 829,00**Prijs incl. BTW  
**€ 1.003,09**

Makpac

**DSD180ZJ**

Gipszaag 18 V

Prijs excl. BTW  
**€ 235,00**Prijs incl. BTW  
**€ 284,35**

Makpac

**DSP600ZJ**Invalcirkelzaag  
165 mm 2 x 18 VPrijs excl. BTW  
**€ 435,00**Prijs incl. BTW  
**€ 526,35**

Makpac

**DSS501ZJ**

Cirkelzaag 136 mm 18 V

Prijs excl. BTW  
**€ 209,00**Prijs incl. BTW  
**€ 252,89**

Makpac

**DST112ZJ**

Nietmachine 18 V

Prijs excl. BTW  
**€ 319,00**Prijs incl. BTW  
**€ 385,99**

Makpac

**DST221ZJ**

Nietmachine 18 V

Prijs excl. BTW  
**€ 335,00**Prijs incl. BTW  
**€ 405,35**

Makpac

**DTD153Z**Slagschroeven-  
draaier 18 VPrijs excl. BTW  
**€ 139,00**Prijs incl. BTW  
**€ 168,19**

Karton

**DTD154ZJ**Slagschroeven-  
draaier 18 VPrijs excl. BTW  
**€ 219,00**Prijs incl. BTW  
**€ 264,99**

Makpac

**DTD156Z**Slagschroeven-  
draaier 18 VPrijs excl. BTW  
**€ 109,00**Prijs incl. BTW  
**€ 131,89**

Karton

**DTD157ZJ**Slagschroeven-  
draaier 18 VPrijs excl. BTW  
**€ 155,00**Prijs incl. BTW  
**€ 187,55**

Makpac

**DTD172ZJ**Slagschroeven-  
draaier 18 VPrijs excl. BTW  
**€ 229,00**Prijs incl. BTW  
**€ 277,09**

Makpac

**DTL061ZJ**Haakse  
slagschroevendraaier 18 VPrijs excl. BTW  
**€ 259,00**Prijs incl. BTW  
**€ 313,39**

Makpac

**DTM51Z**Multitool  
18 VPrijs excl. BTW  
**€ 165,00**Prijs incl. BTW  
**€ 199,65**

Karton

**DTM52ZJ**Multitool  
18 VPrijs excl. BTW  
**€ 249,00**Prijs incl. BTW  
**€ 301,29**

Makpac

**DTW1001ZJ**

Slagmoersleutel 18 V

Prijs excl. BTW  
**€ 389,00**Prijs incl. BTW  
**€ 470,69**

Makpac

**DTW1002ZJ**

Slagmoersleutel 18 V

Prijs excl. BTW  
**€ 395,00**

Prijs incl. BT

ACCU KOFFIEZETAPPARAAT



Ideaal voor op de bouw- en werkplaats. Werkt zowel met koffiepads als met gemalen koffie. Met één accu (LXT 5,0 Ah) maak je 3 koppen koffie van 160 ml.

DCM501Z

Spanning	10,8V/14,4V/18V	
Bijgeleverde accu's	0	
Inhoud waterreservoir	240 ml	
Bereidingstijd met 18 V accu (150 ml)	5 min.	
Gewicht	1,9 - 2,2 kg	
Prijs in €	excl. btw	€ 109,00
	incl. btw	€ 131,89

Promo  
DCM501Z:  
gratis extra accu BL1830B

ACCU WATERKOKER



- Dubbellaagse roestvrijstalen wand
- Met voedingsstandaard en groot handvat
- Uitgerust met morsbeveiliging

DKT360Z

Spanning	2x18V	
Inhoud	0,8 l	
Kooktijd voor 0,8 l	ca. 8 min	
Verwarmcapaciteit 100 °C	1,2 l met 2 x BL1850	
Gewicht	2,7 - 3,4 kg	
Prijs in €	excl. btw	€ 199,00
	incl. btw	€ 240,79

LUCHTPOMP



DMP180Z



Standaard met verschillende ventieladapters



Bedieningspaneel

De DMP181 is uitgerust met een groot display met achtergrondverlichting.



DMP181Z

DMP181

- Drie modi: hoog debiet, laag debiet en "ball" mode om op een veilige manier speelballen op te blazen.
- Functie voor het aflaten van lucht indien de druk te hoog is.

DMP180Z DMP181Z

Spanning	18V	18V
Bijgeleverde accu/lader	-	-
Debiet	10 l/min	11 - 22 l/min
Max. druk	8,3 bar	11,1 bar
Gewicht	1,5 kg	2,5 - 2,8 kg
Prijs in €	excl. btw	€ 99,00
	incl. btw	€ 119,79
Prijs in €	excl. btw	€ 149,00
	incl. btw	€ 180,29

BLAAS- EN ZUIGMACHINE



- Traploos regelbare snelheid met vario-schakelaar en voorkeuze van 4 maximumsnelheden.
- Verschillende mondstukken beschikbaar voor uiteenlopende toepassingen. Standaard worden 5 mondstukken meegeleverd.
- Kan ook gebruikt worden om lucht weg te zuigen via een speciaal opzetstuk (optioneel).
- Ideaal voor het reinigen van gereedschap en onderdelen. Kan ook gebruikt worden om bijvoorbeeld speelgoed voor op het water op te blazen of snel af te laten.



DAS180RT



DAS180Z DAS180RT

Spanning	18V	18V
Bijgeleverde accu	-	1x BL1850B
Max. debiet	1,1 m³/min	1,1 m³/min
Blaaskracht	2,8 N	2,8 N
Max. onderdruk	93 mbar	93 mbar
Gewicht	1,2 - 1,7 kg	1,2 - 1,7 kg
Prijs in €	excl. btw	€ 159,00
	incl. btw	€ 192,39
Prijs in €	excl. btw	€ 299,00
	incl. btw	€ 361,79



ACCU VERWARMD ONDERHEMD

**DCX200 - DCX201**

- DCX200 serie: met open ronde hals. DCX201 serie: met rechtopstaande kraag en halve ritssluiting
- Voeding middels 14,4V/18V LXT-batterij of compacte BL1055B
- Zeer dunne en elastische stof, waardoor het hemd onder andere kleding gedragen kan worden
- Vier warmtezones en 3 warmtestanden
- Machinewasbaar en geschikt voor droogkast



**DEABL1055B**  
Powerbank  
€ 159,00 excl. btw  
€ 192,39 incl. btw



DCX200C

DCX201C

		NIEUW	NIEUW
		DCX200C	DCX201C
Maat	S-M-L-XL-2XL-3XL		
Voeding	14.4V/18V LXT BL1055B	14.4V/18V LXT BL1055B	
Incl. batterijadapter	TD00000111	TD00000111	
Model	Open hals	Met kraag en halve ritssluiting	
Vermogenniveaus	2,3 W / 4,5 W / 9,5 W	2,3 W / 4,5 W / 9,5 W	
Verwarmingszones	4	4	
Materiaal	100% polyester	100% polyester	
Machine wassen/drogen	✓	✓	
Prijs in €	Excl. BTW	€ 165,00	€ 165,00
	Incl. BTW	€ 199,65	€ 199,65

VERWARMD JASSEN / BODYWARMERS CXT & LXT



CJ105  
DCJ205



CJ106  
DCJ206



CV102  
DCV202

CJ106 EN DCJ206:  
HIGH VISIBILITY  
(CONFORM  
ISO 20471/ANSI107)

CV102 EN DCV202:  
ZONDER MOUWEN  
(BODYWARMER)

		CJ105DZ	DCJ205Z	CJ106DZ	DCJ206Z	CV102DZ	DCV202Z
Maat	S-M-L-XL-2XL-3XL						
Spanning	10,8 V	18 V	10,8 V	18 V	10,8 V	18 V	
Model	Jas - zwart	Jas - zwart	Jas - High Visibility	Jas - High Visibility	Bodywarmer	Bodywarmer	
Vermogen	2,3 W - 7 W - 11,5 W	2,3 W - 7 W - 11,5 W	2,3 W - 7 W - 11,5 W	2,3 W - 7 W - 11,5 W	2,3 W - 4,5 W - 9,5 W	2,3 W - 4,5 W - 9,5 W	
Verwarmingszones	5	5	5	5	4	4	
Materiaal buitenzijde	Polyester	Polyester	Polyester	Polyester	Polyester Spandex	Polyester Spandex	
Materiaal binnenzijde	Fleece	Fleece	Fleece	Fleece	Fleece	Fleece	
Water- & windresistent	✓	✓	✓	✓	✓	✓	
Machine wassen/drogen	✓	✓	✓	✓	✓	✓	
Aantal zakken	6	6	6	6	4	4	
Prijs in €	Excl. BTW	€ 209,00	€ 215,00	€ 239,00	€ 245,00	€ 175,00	€ 185,00
	Incl. BTW	€ 252,89	€ 260,15	€ 289,19	€ 296,45	€ 211,75	€ 223,85

ACCU VERWARMD DEKEN



DCB200B

**GESCHIKT VOOR  
WASMACHINE &  
DROOGKAST**

		CB100DB	DCB200B
Bijgeleverde accu's	0		
Afmetingen (LxB)	700 x 1400 mm		
Vermogen	2,3 W - 4,5 W - 9,5 W		
Materiaal	Polyester		
Spanning	10,8 V	14,4 V	18 V
Prijs in €	excl. btw	€ 135,00	€ 139,00
	incl. btw	€ 163,35	€ 168,19

ACCU BLUETOOTH-SPEAKERS



**DMR202**  
BLUETOOTH-SPEAKER  
MET MEDIASPELER  
€ 145,00 excl. btw  
€ 175,45 incl. btw

LCD-display

USB-  
mediaspeler



Equalizer

**DMR203**  
BLUETOOTH-SPEAKER  
MET KOPPELFUNCTIE  
€ 155,00 excl. btw  
€ 187,55 incl. btw

Koppelbaar  
per 2: True Wireless Stereo  
tot 10: simultaan luisteren

ACCU RADIO'S



<b>MR003GZ</b> WERFRADIO XGT/ LXT € 189,00 excl. btw € 228,69 incl. btw	<b>MR004GZ</b> WERFRADIO XGT/ LXT € 225,00 excl. btw € 272,25 incl. btw	<b>MR007GZ</b> WERFRADIO XGT/ LXT € 269,00 excl. btw € 325,49 incl. btw	<b>DMR301</b> WERFRADIO CXT/LXT € 339,00 excl. btw € 410,19 incl. btw	<b>DMR056</b> RADIO MET LANTAARN LXT € 159,00 excl. btw € 192,39 incl. btw	<b>MR009GZ</b> RADIO MET LANTAARN XGT € 145,00 excl. btw € 175,45 incl. btw



DMR301 met laadfunctie voor LXT / CXT accu's

GEREEDSCHAPSETS IN KOFFER

Onze favoriet!  
E-10883 : 221-delige gereedschapskoffer voor kleine herstellingen



Scan mij voor meer info!



**E-10883**  
GEREEDSCHAPSET  
221-DELIG  
€ 140,00 excl. btw  
€ 169,40 incl. btw

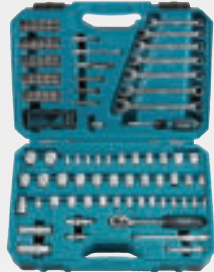

**E-06616**  
GEREEDSCHAPSKOFFER  
120-DELIG  
€ 111,00 excl. btw  
€ 134,30 incl. btw

MAKPAC OPBERGSYSTEEM



- Inclusief 5 types van bakjes : 150x150 mm (1), 150x100 mm (1), 100x100 mm (2), 100x50 mm (3) en 50x50 mm (6)
- Bijkomende inzetbakjes zijn apart te verkrijgen
- Flexibel indeelbaar
- Koppelbaar met Makita Makpacs, Makstors, Makpac trolley TR00000001 en Makpac transportkar P-83886

**191X80-2**  
395 x 295 x 110 mm  
2,3 kg  
€ 70,40 excl. btw  
€ 85,20 incl. btw

MAKSTORS



P-84311 Makstor nr. 3 met 4 lades.



P-84333 Makstor nr. 3 met 6 lades



P-84327 Makstor nr. 3 met 12 lades



P-84349 Makstor nr. 4 met 5 lades

Koppelbaar met alle Makita Makpacs, alsook met Makpac IV koelbox 198253-4, de Makpac trolley TR00000001 en de Makpac transportkar P-83886

De lades van de Makstor zijn flexibel indeelbaar. Standaard worden er bij deze Makstor 8 verdelers / tussenschotten geleverd. De lades zijn voorzien van een vergrendelingssysteem en kunnen gelabeld worden

IDEAAL OM LOS MATERIAAL IN TE BEWAREN ZOALS BOREN EN BITSEN

Omschrijving	Ref.	Indeling	Afmetingen	Prijs excl. btw	Prijs incl. btw
Makstor nr. 3-4	P-84311	4 lades (1 groot / 2 klein / 1 middelgrote)	395 (L) x 295 (B) x 210 (H) mm	€ 159,00	€ 192,39
Makstor nr. 3-12	P-84327	12 kleine lades	395 (L) x 295 (B) x 210 (H) mm	€ 179,00	€ 216,60
Makstor nr. 3-6	P-84333	6 middelgrote lades	396 (L) x 295 (B) x 210 (H) mm	€ 179,00	€ 216,60
Makstor nr. 4-5	P-84349	5 lades (2 groot / 2 klein / 1 middelgrote)	395 (L) x 295 (B) x 320 (H) mm	€ 199,00	€ 240,80

# LAMPEN

## ZAKLAMPEN CXT



	DEAML103	DEAML104	DEAML105	DEAML106	
Spanning	10,8 V (12Vmax)	10,8 V (12Vmax)	10,8 V (12Vmax)	10,8 V (12Vmax)	
Max. lichtstroom	100 lm	710 lm	190 lm	190 lm	
Verlichtingssterkte op 1 m	50 lx	340 lx (0,5 m, lantaarn)	5500 lx	170 - 4500 lx	
Werkingsduur bij max intensiteit, accu BL1041B	28 u.	5,5 u.	14 u.	12 u.	
Specifieke functionaliteiten	Uiterst compact	Lantaarn (360°) en zaklamp (gericht) USB uitgang	Reflector in 12 posities verstelbaar	Zoom functie	
Afmetingen	77 x 54 x 28 mm	414 x 66 x 132 mm	249 x 66 x 93 mm	271 x 66 x 93 mm	
Gewicht	0,27 - 0,43 kg	0,61 - 0,78 kg	0,53 - 0,7 kg	0,61 - 0,78	
Prijs in €	excl. btw	€ 35,70	€ 95,00	€ 55,00	€ 65,00
	incl. btw	€ 43,20	€ 115,00	€ 66,60	€ 78,70

### DEADML105 - DEADML815 - DEAML001G

Reflector 170° kantelbaar in 12 stappen

170°



### DEADML104 - DEBDML806 - DEBDML807 - DEAML002G

3 modi: 360° zijdelings licht, 180° zijdelings licht en gericht licht (bovenaan).  
USB uitgang Type A: 5V 2,4 A (behalve DEBDML806)

#### 3 MODI



#### USB uitgang



### BEADML810

Ontwerp met laag zwaartepunt zodat de lamp niet kan omvallen



## WERFLAMPEN LXT



	DEADML805	DEADML811	DEADML809	BEADML810	DML813	DML814	
Spanning	18 V / 14,4 V / AC	18 V / 14,4 V / AC	18 V / 14,4 V / AC	18 V / 14,4 V / AC	18 V / 14,4 V	18 V / 14,4 V	
Max. lichtstroom	750 lm	3000 lm	10000 lm	5500 lm	3000 lx	3000 lx	
Verlichtingssterkte op 1 m	300 lx	1800 lx	3800 lx	550 lx	1250 lx	1250 lx	
Verlichtingssterkte op 3 m	-	200 lx	380 lx	70 lx	130 lx	130 lx	
Verlichtingssterkte op 5 m	-	85 lx	150 lx	25 lx	50 lx	50 lx	
Verlichtingscapaciteit naar voor/zijdelings	-	6 m/6 m	10 m/10 m	360°, ± 4 m	4,5 m/5,3 m	4,7 m/5,6 m	
Werkingsduur bij max intensiteit, accu BL1850B	8,5 u.	3 u.	1,4 u (2x BL1850B)	3,5 u.	3 u. (2x BL1850B)	3 u. (2x BL1850B)	
Specifieke functionaliteiten	DC/AC 2 helderheidsniveaus	DC/AC 3 helderheidsniveaus	DC/AC 3 helderheidsniveaus	DC/AC 3 helderheidsniveaus	Geïntegreerd statief	Geïntegreerd statief Met 3 afzonderlijk richtbare lichtunits	
Afmetingen	214 x 261 x 328 mm	249 x 302 x 361 mm	249 x 379 x 370 mm	420 x 420 x 787 mm	573 x 658 x 1250-2240 mm	573 x 658 x 1250-2240 mm	
Gewicht	2,3 - 2,7 kg	4,1 - 4,8 kg	5,7 - 7,0 kg	13,9 - 15,3 kg	7,2 - 7,9 kg	7,4 - 8,1 kg	
Prijs in €	excl. btw	€ 169,00	€ 280,10	€ 409,80	€ 499,00	€ 369,00	€ 389,00
	incl. btw	€ 204,50	€ 338,90	€ 495,90	€ 603,80	€ 446,50	€ 470,70

### DML813-DML814

Uitschuifbaar van 1250 mm tot 2240 mm  
Gemakkelijk opvouwbaar voor transport



ZAKLAMPEN LXT



	DEADML803	DEBDML186	DEBDML800	DEBDML815	DEBDML808	DEADML816	DEBDML806	DECDML807	DEADML817	DEBDML812
Spanning	18V/14,4V	18V/14,4V	18V/14,4V	18V/14,4V	18V/14,4V	18V/14,4V	18V/14,4V	18V/14,4V	18V/14,4V	18V/14,4V
Max. lichtstroom	170 lm	-	100 lm	160 lm	190 lm	500 lm	620 lm (lantaarn)	710 lm (lantaarn)	300 lm	1000 lm (flood)
Verlichtingssterkte op 1 m	270 lx (0,5 m)	500 lx	2000 lx	3000 lx	170 - 4500 lx	800 lx (1m)	310 lx (0,5 m, lantaarn)	340 lx (0,5 m, lantaarn)	240 lx (0,5 m)	520 lx (0,5 m flood)
Werkingsduur bij max intensiteit, accu BL1850B	26 u.	83 u.	33 u.	45 u.	26 u.	75 h	21 u.	23 u.	23 u.	6,5 u (flood)
Specifieke functionaliteiten	Batterijhouder met riembevestiging	Met handriem	Hoofdlamp	Reflector in 12 posities kantelbaar	Zoom functie	Reflector draaibaar en kantelbaar	Lantaarn (360°) en zaklamp (gericht)	Lantaarn (360°) en zaklamp (gericht) USB uitgang	3 verlichtingsmodi USB uitgang	Modi: spot, flood, spot + flood
Afmetingen	133 x 81 x 72 mm	151 x 81 x 61 mm	133 x 76 x 88 mm	256 x 79 x 99 mm	280 x 79 x 10 mm	383 x 79 x 110 mm	365 x 78 x 119 mm	414 x 79 x 155 mm	107 x 77 x 50 mm	313 x 119 x 115 mm
Gewicht	0,56 - 0,92 kg	0,51 - 0,83 kg	0,58 - 0,64 kg	0,26 - 0,93 kg	0,73 - 1,09 kg	0,70 - 1,1 kg	0,69 - 1,1 kg	0,72 - 1,1 kg	0,51 - 0,88 kg	1,2 - 1,6 kg
Prijs in €	excl. btw	€ 53,00	€ 39,00	€ 50,00	€ 55,00	€ 60,20	€ 60,20	€ 70,30	€ 95,00	€ 149,00
	incl. btw	€ 64,10	€ 47,19	€ 60,50	€ 66,60	€ 72,80	€ 72,80	€ 85,10	€ 114,95	€ 180,30

DEADML801- DEADML006G

De lichtkop is draaibaar, kantelbaar en opvouwbaar



**Lichtstroom (Lumen, lm):** de hoeveelheid uitgestraald licht per tijdseenheid. Het is een maat voor het vermogen van de lamp.

**Verlichtingssterkte (Lux, lx):** de lichtstroom per oppervlakte of dus de mate waarin een vlak verlicht wordt. De verlichtingssterkte is afhankelijk van de afstand tot de lichtbron.

**Verlichtingscapaciteit:** de zone waar de verlichtingssterkte minstens 70 lx is (de verlichtingssterkte die minimaal nodig is om veilig te kunnen werken).



4.5<sup>Front</sup> m  
(side: 5.3m)



DML813

Verlichtingscapaciteit

WERFLAMPEN LXT & XGT



NIEUW

- EUAML010GZ**
- Voeding middels XGT accu's, LXT accu's of netstroom
  - Tot 4 accu's kunnen tegelijkertijd gemonteerd worden
    - Kan tot 80° kantelen zonder om te vallen
  - Werktijd bij maximum intensiteit: 8,5 uur (2x BL4050F)
    - Beschermingsklasse IP54 (bij werking op accu)



	DEAML003G	DEAML005G	DEAML009G	EUAML010G
Spanning	36V (40Vmax) /18V	36V (40Vmax) /18V	36V (40Vmax) /18V	40Vmax /18V / 14,4 V / AC
Max. lichtstroom	1100 lm	3600 lm	10000 lm	5500 lm
Verlichtingssterkte op 1 m	500 lx	2100 lx	4300 lx	550 lx
Verlichtingssterkte op 3 m	-	230 lx	500 lx	70 lx
Verlichtingssterkte op 5 m	-	90 lx	110 lx	25 lx
Verlichtingscapaciteit naar voor/zijdelings	2,8 m/3,0 m	6,0 m/6,4 m	9,7 m/11,4 m	360°, ± 4 m
Werkingsduur bij max intensiteit, accu BL4040	10 u.	3,5 u.	2,4 u.	6,5 u (2x BL4040)
Specifieke functionaliteiten	2 helderheidsinstellingen	3 helderheidsinstellingen	3 helderheidsinstellingen	DC/AC 3 helderheidsniveaus
Afmetingen	249 x 298 x 280 mm	248 x 309 x 296 mm	248 x 386 x 305 mm	490 x 490 x 814 mm
Gewicht	3,7 - 4,7 kg	4,6 - 6,5 kg	6,4 - 9,9 kg	14,4 - 19,2 kg
Prijs in €	excl. btw	€ 189,20	€ 275,00	€ 399,00
	incl. btw	€ 228,90	€ 332,80	€ 482,79

ACCESSOIRES



Statief voor DML805  
GM00002283  
€ 87,20 excl. btw  
€ 105,51 incl. btw



Spanvijs voor DML805  
GM00001396  
€ 20,80 excl. btw  
€ 25,17 incl. btw



Statief voor DML809 / DML811 / ML003G-  
GM00002073  
€ 195,00 excl. btw  
€ 236,00 incl. btw



Prijzen geldig t.e.m. 31/12/2023

ACCU BL1021B  
12Vmax 2,0 Ah



**197396-9**  
€ 55,00 excl. btw  
€ 66,55 incl. btw

ACCU BL1041B  
12Vmax 4,0 Ah



**197406-2**  
€ 70,00 excl. btw  
€ 84,70 incl. btw

OPLADER DC105B



**197363-4**  
€ 65,00 excl. btw  
€ 78,65 incl. btw

OPLADER DC18RE



**LXT CXT**  
**198720-9**  
€ 139,00 excl. btw  
€ 168,19 incl. btw

## Krachtig Compact Lichtgewicht

POWERPACK 12Vmax  
2 x 2,0 Ah



**197658-5**  
€ 159,00 excl. btw  
€ 192,39 incl. btw

POWERPACK 12Vmax  
2 x 4,0 Ah



**197641-2**  
€ 189,00 excl. btw  
€ 228,69 incl. btw

POWERPACK LXT + CXT



**199026-8**  
€ 279,00 excl. btw  
€ 337,59 incl. btw

POWERPACK LXT + CXT



**199029-2**  
€ 429,00 excl. btw  
€ 519,09 incl. btw

### COMBOPACK CXT



CLX228SAX2



CLX206SAX3



CLX400SAJ1

**PROMO**

gratis lamp  
DEAML103 bij  
CLX228SAX2



CLX228SAX2 CLX206SAX3 CLX400SAJ1

Spanning	10,8V	10,8V	10,8V
Bijgeleverde accu's	3x BL1021B	2x BL1020B	3x BL1020B
Lader	DC105B	DC105A	DC105A
Samenstelling	HP333D TD110D	TM30D DF331D	DF331D TD110D HS301D JR103D
Makpac	-	-	1
Prijs in €	excl. btw	€ 305,00	€ 399,00
	incl. btw	€ 369,05	€ 482,79
		€ 445,00	€ 538,45

ACCU BOOR- EN SCHROEFMACHINES

1/4" BITOPNAME



DF032DSAJ



DF033DWAJ

		DF033DWAJ	DF033DWMJ	DF032DSAJ	DF032DSMJ
Spanning		10,8 V	10,8 V	10,8 V	10,8 V
Bijgeleverde accu's		2 x BL1021B	2 x BL1040B	2 x BL1020B	2 x BL1040B
Hard koppel		30 Nm	30 Nm	35 Nm	35 Nm
BL-motor		-	-	✓	✓
Gewicht		0,9 kg	0,9 kg	0,9 kg	0,9 kg
Prijs in €	excl. btw	€ 189,00	€ 209,00	€ 235,00	€ 265,00
	incl. btw	€ 228,69	€ 252,89	€ 284,35	€ 320,65

ACCU BOOR- EN SCHROEFMACHINES



DF331DSMJ



DF333DNX10

DF333DNX10

Accu boor- & schroefmachine		DF333
Bijgeleverde accu's		2 x BL1850B
Bijgeleverde accu's		1 x BL1021B
Lader		DC18RE
BL-motor		-
Prijs in €	excl. btw	€ 385,00
	incl. btw	€ 465,85

		DF333DWAJ	DF333DWMJ	DF332DSAJ	DF332DSMJ
Spanning		10,8 V	10,8 V	10,8 V	10,8 V
Bijgeleverde accu's		2 x BL1021B	2 x BL1041B	2 x BL1020B	2 x BL1040B
Hard koppel		30 Nm	30 Nm	35 Nm	35 Nm
BL-motor		-	-	✓	✓
Gewicht		1,1 kg	1,1 kg	1,2 kg	1,2 kg
Prijs in €	excl. btw	€ 195,00	€ 225,00	€ 239,00	€ 265,00
	incl. btw	€ 235,95	€ 272,25	€ 289,19	€ 320,65

ACCU KLOPBOOR- EN SCHROEFMACHINES



HP332DSMJ



HP333DWAJ

		HP333DWAJ	HP332DSAJ	HP332DSMJ
Spanning		10,8 V	10,8 V	10,8 V
Bijgeleverde accu's		2 x BL1021B	2 x BL1020B	2 x BL1040B
Hard koppel		30 Nm	35 Nm	35 Nm
BL-motor		-	✓	✓
Gewicht		1,1 kg	1,1 kg	1,3 kg
Prijs in €	excl. btw	€ 205,00	€ 249,00	€ 279,00
	incl. btw	€ 248,05	€ 301,29	€ 337,59

ACCU SLAGSCHROEVENDRAAIERS



TD111DSMJ



TD110DSAJ

Assist modus voor het vlot aanzetten bij het schroeven.

		TD110DSAJ	TD110DSMJ	TD111DZJ	TD111DSAJ	TD111DSMJ
Spanning		10,8 V	10,8 V	10,8 V	10,8 V	10,8 V
Bijgeleverde accu's		2 x BL1020B	2 x BL1040B	0	2 x BL1020B	2 x BL1040B
Max. koppel		110 Nm	110 Nm	135 Nm	135 Nm	135 Nm
BL-motor		-	-	✓	✓	✓
Assist modus		-	-	✓	✓	✓
Gewicht		1,0 kg	1,0 kg	1,0 kg	1,0 kg	1,0 kg
Prijs in €	excl. btw	€ 209,00	€ 239,00	€ 149,00	€ 249,00	€ 279,00
	incl. btw	€ 252,89	€ 289,19	€ 180,29	€ 301,29	€ 337,59

SCHROEFBITSET (35 STUKS) IMPACT BLACK



Schroefbitset B-66880

35 stuks Impact Black  
€ 44,90 excl. btw  
€ 54,30 incl. btw

ACCU BOORHAMERS SDS-PLUS



10.8V

12V max LITHIUM-ION



HR166DSMJ

HR140DSAJ

		HR140DSAJ	HR140DSMJ	HR166DSMJ
Spanning		10,8 V	10,8 V	10,8 V
Bijgeleverde accu's		2 x BL1020B	2 x BL1040B	2 x BL1040B
Slagenergie		1,0 J	1,0 J	1,1 J
Max. Ø beton		14 mm	14 mm	16 mm
BL-motor		-	-	✓
Gewicht		1,9 kg	1,9 kg	1,8 kg
Prijs in €	excl. btw	€ 249,00	€ 295,00	€ 335,00
	incl. btw	€ 301,29	€ 356,95	€ 405,35

ACCU HAAKSE BOORMACHINES



CXT

10.8V

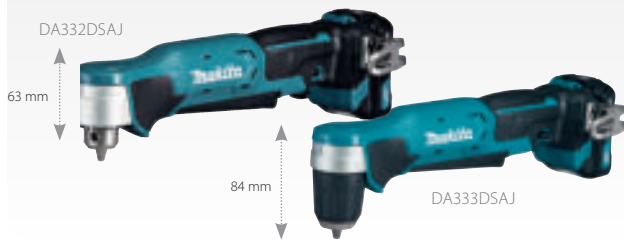

DA332DSAJ

DA333DSAJ

		DA332DSAJ	DA332DSMJ	DA333DSAJ	DA333DSMJ
Spanning		10,8 V	10,8 V	10,8 V	10,8 V
Bijgeleverde accu's		2 x BL1020B	2 x BL1040B	2 x BL1020B	2 x BL1040B
Boorkop		1,5-10 mm	1,5-10 mm	1,5-10 mm	1,5-10 mm
Gewicht		1,2 kg	1,2 kg	1,2 kg	1,2 kg
Prijs in €	excl. btw	€ 215,00	€ 255,00	€ 215,00	€ 255,00
	incl. btw	€ 260,15	€ 308,55	€ 260,15	€ 308,55

ACCU HAAKSE SLAGSCHROEVENDRAAIERS



10.8V

TL064DZJ



Opname 1/4"

TL065DZJ



Opname 3/8"

		TL064DZJ	TL065DZJ
Spanning		10,8 V	10,8 V
Bijgeleverde accu's		0	0
Toerental		0-2000 t.p.m.	0-2000 t.p.m.
Gewicht		1,2 kg	1,2 kg
Prijs in €	excl. btw	€ 199,00	€ 205,00
	incl. btw	€ 240,79	€ 248,05

ACCU SLAGMOERSLEUTELS



CXT

10.8V

12V max LITHIUM-ION



TW141DSMJ

TW161DSMJ

**Reverse Auto-stop:**  
Rotatie stopt automatisch wanneer de bout of moer is losgedraaid

		TW140DZJ	TW140DSAJ	TW140DSMJ	TW141DZJ	TW141DSMJ	TW160DZJ	TW160DSAJ	TW160DSMJ	TW161DZJ	TW161DSMJ
Spanning		10,8 V	10,8 V	10,8 V	10,8 V	10,8 V	10,8 V	10,8 V	10,8 V	10,8 V	10,8 V
Bijgeleverde accu's		0	2 x BL1021B	2 x BL1041B	0	2 x BL1041B	0	2 x BL1021B	2 x BL1041B	0	2 x BL1041B
Toerental		0-2600 t.p.m.	0-2600 t.p.m.	0-2600 t.p.m.	0-2600 t.p.m.	0-2600 t.p.m.	0-1300 t.p.m. 0-2400 t.p.m.	0-1300 t.p.m. 0-2400 t.p.m.	0-1300 t.p.m. 0-2400 t.p.m.	0-1300 t.p.m. 0-2400 t.p.m.	0-1300 t.p.m. 0-2400 t.p.m.
Max. koppel		140 Nm	140 Nm	140 Nm	145 Nm	145 Nm	165 Nm	165 Nm	165 Nm	165 Nm	165 Nm
Snelheden		1	1	1	1	1	2	2	2	2	2
Auto-stop functie		-	-	-	-	-	✓	✓	✓	✓	✓
Opname		3/8"	3/8"	3/8"	1/2"	1/2"	3/8"	3/8"	3/8"	1/2"	1/2"
BL-motor		-	-	-	-	-	✓	✓	✓	✓	✓
Gewicht		1,0 kg	1,0 kg	1,0 kg	1,1 kg	1,1 kg	1,0 kg	1,0 kg	1,0 kg	1,1 kg	1,1 kg
Prijs in €	excl. btw	€ 125,00	€ 235,00	€ 265,00	€ 129,00	€ 265,00	€ 159,00	€ 265,00	€ 305,00	€ 165,00	€ 305,00
	incl. btw	€ 151,25	€ 284,35	€ 320,65	€ 156,09	€ 320,65	€ 192,39	€ 320,65	€ 369,05	€ 199,65	€ 369,05



ACCU RATELMOERSLEUTEL



Geleverd met 1/4" & 3/8" opname

Verwijderbare kop laat toe om 13 mm moeren over de lengte van een M8 draadstang te schroeven.



		WR100DZ
Spanning		10,8V
Toerental onbelast		800 t.p.m.
Max. koppel		47,5 Nm
Bijgeleverde accu's		-
Gewicht		1,0 kg
Prijs in €	excl. btw	€ 209,00
	incl. btw	€ 252,89

ACCU NIETMACHINE



ST113DSAJ

Met repeteerfunctie en anti-droogschietmechanisme

		ST113DZJ	ST113DSAJ	ST113DSMJ
Spanning		10,8V	10,8V	10,8V
Bijgeleverde accu's		-	2 x BL1020B	2 x BL1040B
Rugbreedte niet		10 mm	10 mm	10 mm
Ladercapaciteit		150 stuks	150 stuks	150 stuks
Gewicht		1,3 kg	1,3 kg	1,5 kg
Prijs in €	excl. btw	€ 275,00	€ 365,00	€ 399,00
	incl. btw	€ 332,75	€ 441,65	€ 482,79

ACCU PINPISTOOL



PT354DZJ

		PT354DZJ
Spanning		10,8V
Bijgeleverde accu's		-
Draadkaliber		23 Ga
Doorsnede nagel		0,6 mm
Lengte nagel		15-35 mm
Gewicht		2,0 kg
Prijs in €	excl. btw	€ 345,00
	incl. btw	€ 417,45

LUCHTPOMP



MP100DZ

Spanning		10,8V
Bijgeleverde accu's		-
Debiet		10 l/min (bij 2 bar)
Max. druk		8,3 bar
Gewicht		1,2 kg
Prijs in €	excl. btw	€ 89,00
	incl. btw	€ 107,69

ACCU SCHUUR-/POLIJSTMACHINE 75 MM



- Geleverd met adapter voor Roloc™ voor schuurtoepassingen en een velcro steunschijf voor het polijsten
- Ideaal voor oppervlaktebehandeling en voor het polijsten van kleine oppervlakken



		PV301DZJ	PV301DSAEJ
Spanning		10,8V	10,8V
Bijgeleverde accu's		-	2x BL1021B
Capaciteit polijsten		80 mm	80 mm
Capaciteit schuren		50 mm	50 mm
Toerental polijsten		0-2800 min <sup>-1</sup>	0-2800 min <sup>-1</sup>
Toerental schuren		0-9500 min <sup>-1</sup>	0-9500 min <sup>-1</sup>
Gewicht		1,1 kg	1,1 kg
Prijs in €	excl. btw	€ 275,00	€ 375,00
	incl. btw	€ 332,75	€ 453,75

ACCU CIRKELZAAG 85 MM



HS301DSAJ

		HS301DSAJ	HS301DSMJ
Spanning		10,8V	10,8V
Bijgeleverde accu's		2 x BL1020B	2 x BL1040B
Max. zaagdiepte bij (90°)		25,5 mm	25,5 mm
Ø Zaagblad		85 mm	85 mm
Gewicht		1,6 kg	1,6 kg
Prijs in €	excl. btw	€ 219,00	€ 255,00
	incl. btw	€ 264,99	€ 308,55

ACCU TEGELSNIJDER 85 MM



CC301DSMJ



		CC301DZJ	CC301DSMJ
Spanning		10,8V	10,8V
Bijgeleverde accu's		-	2 x BL1040B
Zaagdiepte (90°)		25,5 mm	25,5 mm
Ø Zaagblad		85 mm	85 mm
Gewicht		1,9 kg	1,9 kg
Prijs in €	excl. btw	€ 169,00	€ 299,00
	incl. btw	€ 204,49	€ 361,79

ACCU DRAADSTANGKNIPPER



Voor gebruiksklaar afkorten zonder vonken!

SC103DZJ

Spanning		10,8V
Bijgeleverde accu's		-
Afkorten		Mobiel
Snijcapaciteit		M6 - M8 - M10
Inbegrepen mes		M8, M10
Gewicht		2,7 kg
Prijs in €	excl. btw	€ 639,00
	incl. btw	€ 773,19

ACCU MULTICUTTER



CP100DZJ

Spanning		10,8V
Bijgeleverde accu's		-
Snijcapaciteit		6 mm
Gewicht		0,72 kg
Prijs in €	excl. btw	€ 89,00
	incl. btw	€ 107,69

ACCU GIPSZAAG



SD100DZJ

Spanning		10,8V
Bijgeleverde accu's		-
Slaglengte		6 mm
Snijcapaciteit		30 mm
Gewicht		1,5 kg
Prijs in €	excl. btw	€ 245,00
	incl. btw	€ 296,45

ACCU DECOUPEERZAGEN

10.8v CXT



JV102DSAJ



JV103DSAJ

	JV101DSAJ	JV102DZJ	JV102DSAJ	JV102DSMJ	JV103DZJ	JV103DSAJ	JV103DSMJ
Spanning	10,8V	10,8V	10,8V	10,8V	10,8V	10,8V	10,8V
Bijgeleverde accu's	2 x BL1020B	0	2 x BL1020B	2 x BL1040B	0	2 x BL1020B	2 x BL1040B
Aantal zaagbewegingen	0-2900 /min	800-3000 /min	800-3000 /min	800-3000 /min	800-3000 /min	800-3000 /min	800-3000 /min
Max. capaciteit hout	65 mm	90 mm	90 mm	90 mm	90 mm	90 mm	90 mm
BL-motor	-	✓	✓	✓	✓	✓	✓
Gewicht	1,8 kg	1,8 kg	1,8 kg	1,8 kg	1,8 kg	1,8 kg	1,8 kg
Prijs in €	excl. btw	€ 235,00	€ 179,00	€ 279,00	€ 309,00	€ 179,00	€ 279,00
	incl. btw	€ 284,35	€ 216,59	€ 337,59	€ 373,89	€ 216,59	€ 337,59

ACCU RECIPROZAAG

10.8v CXT



JR103DSAJ

	JR103DSAJ	JR103DSMJ
Spanning	10,8V	10,8V
Bijgeleverde accu's	2 x BL1020B	2 x BL1040B
Max. zaagcapaciteit hout/stalen buis	50 mm	50 mm
Gewicht	1,3 kg	1,5 kg
Prijs in €	excl. btw	€ 229,00
	incl. btw	€ 277,09

ACCU MULTITOOl

10.8v CXT



TM30DSAJX3

Spanning	10,8V	
Bijgeleverde accu's	2 x BL1020B	
Oscillatiehoek	3,2°	
Oscillatiefrequentie	6000-20000 min <sup>-1</sup>	
Opname	OIS, Starlock	
Gewicht	1,1 kg	
Prijs in €	excl. btw	€ 335,00
	incl. btw	€ 405,35

ACCU KITPISTOOL

CXT 10.8v



CG100DSAEA

CG100DSAEB

CG100DSAEB met aluminium kokerhouder 600 ml (voor worsten of kit in bulkverpakking)

	CG100DSAEA	CG100DSAEB
Spanning	10,8V	10,8V
Bijgeleverde accu's	2 x BL1020B	2 x BL1020B
Max. extrusiekracht	5000 N	5000 N
Max. extrusiesnelheid	0-28 mm/s	0-28 mm/s
Prijs in €	excl. btw	€ 325,00
	incl. btw	€ 393,25

STEELOFZUIGERS MET GEÏNTEGREERDE ACCU



	CL114DWIX	CL117FDX2	CL117FDX5	CL117FDX8
Spanning	10,8 V	10,8 V	10,8 V	10,8 V
Bijgeleverde accu's	Geïntegreerd	Geïntegreerd	Geïntegreerd	Geïntegreerd
Max. debiet	1,4 m³/min	1,0 m³/min	1,0 m³/min	1,0 m³/min
Max. onderdruk	34 mbar	50 mbar	50 mbar	50 mbar
Stofopvang	Stofzak	Capsule	Capsule	Capsule
Klikvergrendeling	✓	✓	✓	✓
Kleur	Beige	Turquoise	Groen	Purper
Promo	-	-	-	-
Gewicht	0,94 kg	1,0 kg	1,0 kg	1,0 kg
Prijs in €	excl. btw	€ 119,00	€ 125,00	€ 125,00
	incl. btw	€ 143,99	€ 151,25	€ 151,25

CYCLONMODULE

- ✓ Het grove stof wordt van het fijne stof gescheiden.
- ✓ Stofzak of capsule voor het fijn stof tot 80 % minder vaak ledigen!
- ✓ Het reservoir van de module is zeer gemakkelijk te ledigen en uit te wassen.

Gemakkelijk te ledigen

Extra opvangcapaciteit  
**400 ml**



191D71-3

OPTIONELE ACCESSOIRES



Muurbevestiging 199971-7 € 13,40 excl. btw € 16,20 incl. btw	Vloerzuigmond tapijt 198527-3 € 16,80 excl. btw € 20,30 incl. btw	Kierzuigmond lang 198990-0 € 6,70 excl. btw € 8,10 incl. btw	Ronde borstel 198553-2 € 10,10 excl. € 12,22 incl.
---	--	---	---

Ref.	Kleur	Prijs excl. btw	Prijs incl. btw
Cyclonmodule met klikvergrendeling			
191D71-3	wit	€ 39,10	€ 47,30
191D73-9	zwart	€ 39,10	€ 47,30
Cyclonmodule zonder klikvergrendeling			
199491-1	wit	€ 33,50	€ 40,50
191d75-5	zwart	€ 33,50	€ 40,50

STEELOFZUIGERS CXT/ LXT



**PROMO:**  
DCL182Z: gratis cyclon 199491-1 + muurbevestiging  
DCL280FZW: gratis cyclon 191D71-3 + muurbevestiging

**DCL284, DCL285 & DCL286:**

- Nieuwe brushless motor levert hoge zuigkracht.
- Laag geluidsniveau door vernieuwd ontwerp van luchtuitlaat.
- De DCL286 heeft een ingebouwde cyclonmodule: deze vangt grove stofdeeltjes op waardoor de optimale zuigkracht langer behouden blijft.



	CL102DW	CL107FDZW	DCL180ZB	DCL182Z	DCL280FZW	DCL282FZ	DCL284FZB	DCL284FRFB	DCL285FZ	DCL285FRF	DCL286FZW	DCL286FRFW
Spanning	10,8 V	10,8 V (CXT)	18 V (LXT)	18 V (LXT)	18 V (LXT)	18 V (LXT)	18 V (LXT)	18 V (LXT)	18 V (LXT)	18 V (LXT)	18 V (LXT)	18 V (LXT)
Bijgeleverde accu's	1 x BL1013	-	-	-	-	-	-	1x BL1830	-	1x BL1830	-	1x BL1830
Max. debiet	0,9 m³/min	1,4 m³/min	1,4 m³/min	1,4 m³/min	1,5 m³/min	1,5 m³/min	1,2 m³/min	1,2 m³/min	1,2 m³/min	1,2 m³/min	1,0 m³/min	1,0 m³/min
Max. onderdruk	23 mbar	50 mbar	42 mbar	54 mbar	60 mbar	82 mbar	180 mbar	180 mbar	180 mbar	180 mbar	180 mbar	180 mbar
Stofopvang	Stofzak	Stofzak	Capsule	Stofzak	Capsule	Stofzak	Capsule	Capsule	Stofzak	Stofzak	Cyclon	Cyclon
Klikvergrendeling	-	-	-	-	✓	✓	✓	✓	✓	✓	✓	✓
BL motor	-	-	-	-	✓	✓	✓	✓	✓	✓	✓	✓
Kleur	Wit	wit	Zwart	Blauw	Wit	Blauw	zwart/turquoise	zwart/turquoise	Blauw	Blauw	Wit	Wit
Gewicht	1,1 kg	1,1 - 1,3 kg	1,2 kg	1,3 kg	1,2 - 1,6 kg	1,3 - 1,6 kg	1,3 - 1,6 kg	1,3 - 1,6 kg	1,4 - 1,7 kg	1,4 - 1,7 kg	1,6 - 1,9 kg	1,6 - 1,9 kg
Prijs in €	excl. btw	€ 99,00	€ 79,00	€ 75,00	€ 79,00	€ 149,00	€ 149,00	€ 155,00	€ 279,00	€ 165,00	€ 289,00	€ 169,00
	incl. btw	€ 119,79	€ 95,59	€ 90,75	€ 95,59	€ 180,29	€ 180,29	€ 187,55	€ 337,59	€ 199,65	€ 349,69	€ 204,49

XGT STEELSTOFZUIGERS



CL002GD205

CL001GD208



CL002GD212

	CL001GZ05	CL001GD208	CL002GZ03	CL002GD205	CL002GZ07	CL002GD212	CL003GZ04
Spanning	40Vmax	40Vmax	40Vmax	40Vmax	40Vmax	40Vmax	40Vmax
Bijgeleverde accu's	-	2x BL4025	-	2x BL4025	-	2x BL4025	-
Bijgeleverde lader	-	DC40RA	-	DC40RA	-	DC40RA	-
Max. debiet	1,2 m³/min	1,2 m³/min	1,2 m³/min	1,2 m³/min	1,2 m³/min	1,2 m³/min	1,0 m³/min
Max. onderdruk	210 mbar	210 mbar	210 mbar	210 mbar	210 mbar	210 mbar	200 mbar
Stofopvang	Capsule	Capsule	Stofzak	Stofzak	Stofzak	Stofzak	Cycloon-capsule
Klikvergrendeling	✓	✓	✓	✓	✓	✓	✓
Kleur	Turquoise	Turquoise	Zwart	Zwart	Wit	Wit	Zwart
Gewicht	1,7 - 2,3 kg	1,7 - 2,3 kg	1,7 - 2,3 kg	1,7 - 2,3 kg	1,7 - 2,3 kg	1,7 - 2,3 kg	1,9 - 2,5 kg
Prijs in €	excl. btw	€ 165,00	€ 525,00	€ 159,00	€ 519,00	€ 159,00	€ 519,00
	incl. btw	€ 199,65	€ 635,25	€ 192,39	€ 627,99	€ 192,39	€ 627,99

CLEANING COMBOPACK



CLX245SAX1

Spanning	10,8V	
Meegeleverde accu's	1 x BL1021B	
Lader	DC10SB	
Stofstofzuiger	CL108FDZW	
Blaas-/ zuigmachine	UB100DZ	
Gereedschapstas	✓	
Prijs in €	excl. btw	€ 229,00
	incl. btw	€ 277,09

ACCU CYCLOONSTOFZUIGER



DCL501Z

DCL501Z

Spanning	18V	
Bijgeleverde accu's	0	
Max. debiet	1,3 m³/min	
Max. onderdruk	66 mbar	
Gewicht	3,1 kg	
Prijs in €	excl. btw	€ 349,00
	incl. btw	€ 422,29

# Technologie



Auto-start wireless system

## Geniet van stofvrij werken met AWS!

Bij het starten van de accu-machine wordt de stofzuiging automatisch geactiveerd d.m.v. een Bluetooth verbinding. Wanneer het verbonden toestel uitgeschakeld wordt, gaat de stofzuiger weer in stand-by modus. Sommige accustofzuigers zoals VC009 of DVC867 hebben AWS reeds standaard ingebouwd en kunnen dus rechtstreeks communiceren met AWS-compatibele gereedschappen.

Via de optionele adapter WUT02U kunnen nu ook stofzuigers op netstroom draadloos aangestuurd worden, ongeacht het merk. De enige vereiste is dat de stofzuiger met een startautomatiek uitgerust is.

AWS-compatibele stofzuiger



DVC867L



Stofzuiger met startautomatiek



Adapter WUT02U 199773-1  
€ 205,80 excl. btw  
€ 249,00 incl. btw



Bluetooth unit 198900-7  
€ 62,50 excl. btw  
€ 75,60 incl. btw

ACCU BLAAS- EN ZUIGMACHINE



Prijzen DUB186Z en UB101DZ geldig t.e.m. 31/12/2023

**UB101DZ & DUB186:**  
uitvoering met lange pijp,  
ideaal om laag bij de grond  
te blazen.



DUB186Z

DUB185Z

	UB100DZ	UB101DZ	DUB185Z	DUB186Z
Spanning	10,8V	10,8V	18V	18V
Max. luchtsnelheid	75 m/s	65 m/s	98 m/s	68 m/s
Max. debiet	2,6 m³/min	2,6 m³/min	3,2 m³/min	3,2 m³/min
Gewicht	1,4 kg	1,4 kg	1,6 kg	1,6 kg
Prijs in €	excl. btw	€ 95,00	€ 73,55	€ 95,00
	incl. btw	€ 114,95	€ 89,00	€ 114,95

BLAAS- EN ZUIGMACHINE



Multifunctionele schakelaar met snelheidsinstelling

	UB1103	
Vermogen	600 W	
Max. luchtsnelheid	91 m/s	
Max. debiet	4,1 m³/min	
Gewicht	2,0 kg	
Prijs in €	excl. btw	€ 159,00
	incl. btw	€ 192,39

ACCU RUGGEDRAGEN STOFZUIGERS

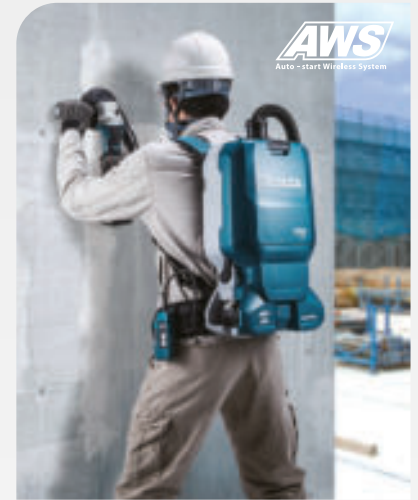

DVC660

DVC665

**DVC660**  
Uitvoering speciaal voor schoonmaak, geleverd met diverse accessoires.

**DVC665**  
Uitvoering voor stofafzuiging in combinatie met machines.



**HEPA-filter**

Als hoofdfilter wordt een HEPA-filter gebruikt die zeer fijne stofdeeltjes effectief tegenhoudt. De filter kan tot 99,97 % van de deeltjes tussen 0,3 en 1 µm filteren, waardoor de uitgeblazen lucht zeer zuiver is.



**Filterreiniging**

Door de trillingen van het stappen of het manueel indrukken van de hendel wordt het fijn stof van de papierfilter geschud. Daardoor blijft de zuigkracht langer optimaal bij het opzuigen van fijn stof.



	DVC265ZXU	DVC261ZX11	DVC660Z	DVC665ZX1U
Spanning	2 x 18V	2 x 18V	2 x 18V	2 x 18V
Max. debiet	1,8-2,2 m³/min	1,8-2,2 m³/min	1,8-2,2 m³/min	1,8-2,2 m³/min
Max. onderdruk	110 mbar	110 mbar	110 mbar	110 mbar
Uitvoering	Stofafzuiging machines	Schoonmaak	Schoonmaak	Stofafzuiging machines
Capaciteit stofzak	2l	2l	6l	6l
AWS	✓	-	-	✓
Gewicht	3,9 kg	3,8 kg	6,1 kg	6,1 kg
Prijs in €	excl. btw	€ 375,00	€ 375,00	€ 415,00
	incl. btw	€ 453,75	€ 405,35	€ 502,15

ACCU RUGGEDRAGEN STOFZUIGERS



VC008GZ



VC009GZ  
(Geleverd zonder batterijen en zonder oplader)

- Hogere zuigkracht dankzij de 40Vmax accutechnologie
- Geluidsarm door een hertekend design van de luchtuitlaat en gebruik van geluidsabsorberend materiaal.
- VC008GZ wordt standaard geleverd met accessoires voor schoonmaakt toepassingen.
- VC009GZ01 wordt geleverd met twee zuigslangen en hulpstukken voor stofafzuiging in combinatie met machines.

	VC008GZ	VC009GZ01
Spanning	40Vmax	40Vmax
Max. debiet	2,4 m³/min	1,9 m³/min
Max. onderdruk	180 mbar	180 mbar
Uitvoering	Schoonmaak	Stofafzuiging machines
Capaciteit stofzak	2,0l	2,0l
AWS	-	✓
Gewicht	4,1 - 5,3 kg	4,1 - 5,3 kg
Prijs in €	excl. btw	€ 369,00
	incl. btw	€ 446,49

ACCU RECHTOPSTAANDE STOFZUIGER

18V + 18V → 36V

Met roterende borstel, ideaal voor tapijt  
 Aparte motor voor het aandrijven van de borstel  
 Telescopische aluminium steel



Met aparte aluminium buis om moeilijk bereikbare plaatsen te reinigen



Zeer wendbaar, geen voedingskabel en geen zuigslang!

3 vermogenstanden



Instelbare hoogte van de borstel (4 hoogtes, max 10 mm)



DVC560Z

Spanning	2 x 18V	
Bijgeleverde accu's	0	
Max. debiet	1,9 m³/min	
Max. onderdruk	120 mbar	
Gewicht	8,3 kg	
Prijs in €	excl. btw	€ 479,00
	incl. btw	€ 579,59

ACCU COMPACTE STOFZUIGER

LXT 18V LITHIUM-ION



Inclusief draagriem, vloerzuigmond & kierzuigmond

DVC750LZX1

Spanning	18V	
Bijgeleverde accu's	0	
Max. debiet	1,4 m³/min	
Max. onderdruk	64 mbar	
Gewicht	4,2 kg	
Prijs in €	excl. btw	€ 219,00
	incl. btw	€ 264,99

ACCU COMPACTE STOFZUIGER

12V max LITHIUM-ION

18V LITHIUM-ION

IDEAAL VOOR DE AUTO



DCL184Z

Met blaasfunctie

Inclusief accessoires

CL121DZJ DCL184Z

Spanning	10,8V	18V	
Bijgeleverde accu's	-	-	
Lader	-	-	
Max. debiet	1,3 m³/min	1,3 m³/min	
Max. onderdruk	44 mbar	47 mbar	
Gewicht	1,7	2,1 kg	
Prijs in €	excl. btw	€ 135,00	€ 129,00
	incl. btw	€ 163,35	€ 156,09

Zuigmond voor matten



Zuigmond voor zetels

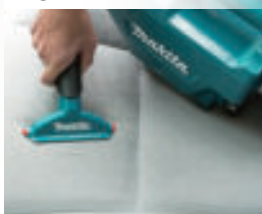

Rubberen zuigmond

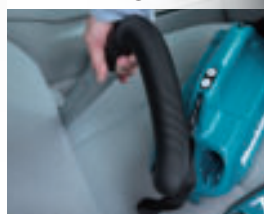

Zachte borstel

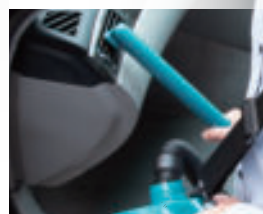

Blaasmond





**DRC200**

- Verschillende sensoren voor obstakel- en grensdetectie
- Patroonmodus voor grote vloeroppervlakken met weinig obstakels, zoals een magazijn of een lange gang
- Willekeurige modus voor vloeroppervlakken met veel obstakels, zoals in een kantoor.
- Door middel van grenstape kan de gebruiker de zone afbakenen waarbinnen de robot mag werken.
- Modi "alleen borstelen" of "stofzuigen + borstelen"
- Bediening op het toestel zelf of met bijgeleverde afstandsbediening
- Werkt op één 18 V accu of twee in parallel. De accu's moeten uit het toestel verwijderd worden om op te laden.



DRC200PTJ

OPPERVLAKTE  
TOT 500 m<sup>2</sup>

**Patroonmodus**

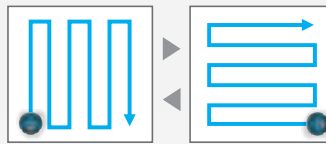

**Willekeurige modus**

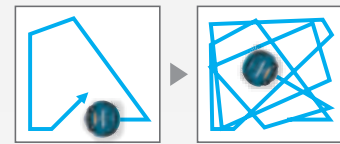

OPPERVLAKTE  
TOT 600 m<sup>2</sup>



DRC300Z



De camera maakt beelden van het plafond ter ondersteuning van de navigatie



**DRC300**

- Kan ruimtes in kaart brengen door gebruik te maken van LiDAR module en beeldcamera. Tot 5 ruimtes kunnen in het geheugen bewaard worden. Dankzij de intelligente positiebepaling kan een ruimte efficiënter gereinigd worden en kan de machine ook automatisch terugkeren naar het beginpunt
- Verschillende sensoren voor obstakel- en grensdetectie
- Modi "alleen borstelen" of "stofzuigen + borstelen"
- Bediening op het toestel zelf, met de afstandsbediening of met de smartphone app (Wifi verbinding)
- Via de smartphone app kunnen de bewaarde kaarten weergegeven en geoptimaliseerd worden (bv. het definiëren van verboden zones) en kan ook schoonmaakstatus en -historiek gecontroleerd worden
- Werkt op één 18 V accu of twee in parallel. De accu's moeten uit het toestel verwijderd worden om op te laden.

**DRC200Z DRC200PTJ DRC300Z**

Spanning		18 V (één of 2 in parallel)		
Bijgeleverde accu's		-	2 x BL1850B	-
Lader		-	DC18RD	-
Capaciteit opvangbak		2,5 l	2,5 l	3,0 l
Max. registreerbare oppervlakte		-	-	10000 m <sup>2</sup>
Max. snelheid		0,3 m/s	0,3 m/s	0,3 m/s
Navigatie		Willekeurig of vast patroon	Willekeurig of vast patroon	Intelligent op basis van kaart
LiDAR sensor		-	-	✓
Camera		-	-	✓
Configuratie en besturing met app		-	-	✓
Afbakenen van verboden zones		Tape	Tape	Tape of via app
Terugkeren naar beginpunt		-	-	✓
Gewicht		6,8 - 7,8 kg	6,8 - 7,8 kg	9,6 - 10,6 kg
Prijs in €	excl. btw	€ 915,00	€ 1.179,00	€ 1.999,00
	incl. btw	€ 1.107,15	€ 1.426,59	€ 2.418,79

ACCU STOFZUIGERS L-KLASSE LXT



	DVC150LZ	DVC155LZX2	DVC863LZ	DVC867LZX4	DVC157LZX3	
Spanning	2 x 18 V / 230 V	2 x 18 V	2 x 18 V	2 x 18 V	2 x 18 V	
Bijgeleverde accu	-	-	-	-	-	
Kuipvolume	15 l	15 l	8 l	8 l	15 l	
Type	Nat & Droog	Nat & Droog	Droog	Droog	Droog	
Filter	Textielfilter	Textielfilter	HEPA	HEPA	HEPA	
Max. debiet	2,1 / 3,6 m <sup>3</sup> /min	2,1 m <sup>3</sup> /min	2,1 m <sup>3</sup> /min	2,4 m <sup>3</sup> /min	2,4 m <sup>3</sup> /min	
Max. onderdruk	90 / 240 mbar	110 mbar	98 mbar	110 mbar	110 mbar	
AWS	-	-	-	✓	✓	
Gewicht	8,9 kg	7,9 kg	7,9 kg	7,8 kg	8,0 kg	
Prijs in €	excl. btw	€ 579,00	€ 449,00	€ 445,00	€ 579,00	€ 599,00
	incl. btw	€ 700,59	€ 543,29	€ 538,45	€ 700,59	€ 724,79

ACCU STOFZUIGERS L-KLASSE XGT



- Voeding met twee 40Vmax accu's in parallel.
- Hoge zuigkracht dankzij hoger vermogen en verbeterde koeling.
- Met telescopische steel (VC001G/VC003G/VC005G)
- Vloerborstel met laag profiel en verstelling voor harde vloer of tapijt (VC001G/VC003G/VC005G).
- VC005G: hoge wendbaarheid en stabiliteit door extra grote wielen achteraan.

**Toepassing:**

- VC001G / VC003G: voor algemeen droog en nat gebruik (schoonmaak).
- VC002G/VC004G: ideaal voor stofafzuiging van machines (met HEPA filter en AWS).
- VC005G: voor algemeen droog gebruik (schoonmaak).

	VC001GLZ	VC003GLZ	VC002GLZ01	VC004GLZ01	VC005GLZ	
Spanning	36 V (40Vmax)	36 V (40Vmax)	36 V (40Vmax)	36 V (40Vmax)	36 V (40Vmax)	
Bijgeleverde accu's	-	-	-	-	-	
Type	Droog/Nat	Droog/Nat	Droog	Droog	Droog	
Capaciteit	8 l	15 l	8 l	15 l	8 l	
Max. debiet	3,2 m <sup>3</sup> /min	3,2 m <sup>3</sup> /min	1,8 m <sup>3</sup> /min	1,8 m <sup>3</sup> /min	2,8 m <sup>3</sup> /min	
Max. onderdruk	230 mbar	230 mbar	230 mbar	230 mbar	230 mbar	
Filter	Textielfilter	Textielfilter	HEPA	HEPA	Textielfilter	
AWS	-	-	✓	✓	-	
Gewicht	8,1 - 10 kg	8,1 - 10 kg	8,3 - 10,2 kg	8,3 - 10,2 kg	7,9 - 9,8 kg	
Prijs in €	excl. btw	€ 469,00	€ 489,00	€ 599,00	€ 619,00	€ 499,00
	incl. btw	€ 567,49	€ 591,69	€ 724,79	€ 748,99	€ 603,79

Gewicht en slagenergie zijn conform met EPTA-procedures.

**WAT BETEKEN L-, M- OF H-KLASSE?**

Stofzuigers voor professioneel gebruik worden volgens EN60335-2-69 ingedeeld in risicoklassen:

**L-klasse** (Low risk) stofzuigers mogen gebruikt worden voor alle stof waarvan de toelaatbare blootstellingswaarde groter is dan  $1 \text{ mg/m}^3$ . Deze stofzuigers laten minder dan 1 % van het opgezogen stof door.

**M-klasse** (Medium risk) stofzuigers mogen gebruikt worden voor alle stof waarvan de toelaatbare blootstellingswaarde groter is dan  $0,1 \text{ mg/m}^3$ . Deze stofzuigers laten minder dan 0,1 % van het opgezogen stof door en voldoen bovendien aan een aantal bijkomende eisen, waaronder permanente debietcontrole en stofarme lediging.

**H-klasse** stofzuigers (High risk) moeten gebruikt worden voor stoffen waarvan de max. blootstellingswaarde  $< 0,1 \text{ mg/m}^3$  bedraagt. Deze stofzuigers laten minder dan 0,005 % van het opgezogen stof door en moeten ook voldoen aan een aantal bijkomende eisen, zoals permanente debietcontrole en stofarme lediging.

Opgelet: stofzuigers zonder aanduiding van de stofklasse volgens EN60335-2-69 bieden geen enkele garantie op het vlak van persoonlijke veiligheid en zijn derhalve niet geschikt voor professioneel gebruik.

## ACCU STOFZUIGERS L-KLASSE XGT



VC007GL, VC006GM: dubbel filtersysteem met automatisch zelfreinigende filter, zonder zuigkrachtonderbreking



- Accu stofzuiger met hoge zuigkracht, vergelijkbaar met model op netstroom
- Stofklasse L, met HEPA-filter
- Nat en droog gebruik, uitgerust met waterniveausensor en waterafvoer
- Automatisch zelfreinigende filter met dubbel filtersysteem
- Inclusief slang 28 mm en 38 mm, gebogen buis en vloerzuigmond
- AWS: de stofzuiger kan automatisch aangestuurd worden door AWS-compatibele powertools

**VC007GLZ01**

Spanning	72 V (80Vmax)	
Bijgeleverde accu's	-	
Lader	-	
Kuipvolume	40 l	
Type	nat/droog	
Filterklasse	L (HEPA)	
Max. debiet (38 mm slang)	3,7 m <sup>3</sup> /min	
Max. debiet (28 mm slang)	2,0 m <sup>3</sup> /min	
Max. onderdruk	180 mbar	
Gewicht	18,3 - 20,7 kg	
Prijs in €	excl. btw	€ 1.219,00
	incl. btw	€ 1.474,99

## ACCU STOFZUIGERS M-KLASSE XGT



De VG006GM heeft een instelling van de slangdiameter en waarschuwingszoemer voor te lage luchtstroom.



- Accu stofzuiger met hoge zuigkracht, vergelijkbaar met model op netstroom
- Stofklasse M
- Nat en droog gebruik, uitgerust met waterniveausensor en waterafvoer
- Automatisch zelfreinigende filter met dubbel filtersysteem
- Inclusief slang 28 mm en 38 mm, gebogen buis en vloerzuigmond
- AWS: de stofzuiger kan automatisch aangestuurd worden door AWS-compatibele powertools

**VC006GMZ01**

Spanning	72 V (80Vmax)	
Bijgeleverde accu's	-	
Lader	-	
Kuipvolume	40 l	
Type	nat/droog	
Filterklasse	M	
Max. debiet (38 mm slang)	3,7 m <sup>3</sup> /min	
Max. debiet (28 mm slang)	2,0 m <sup>3</sup> /min	
Max. onderdruk	180 mbar	
Gewicht	18,4 - 20,8 kg	
Prijs in €	excl. btw	€ 1.279,00
	incl. btw	€ 1.547,59

STOFZUIGERS L-KLASSE

Klasse L  
VC2512L

Klasse L  
VC2000L

Klasse L  
VC3011L

Klasse L  
VC3012L

INCLUSIEF  
1 SET ACCESSOIRES



STOFZUIGERS L-, M- EN H-KLASSE

Klasse L  
VC2510LX1

Klasse L  
VC3210LX1

Klasse M  
VC3211MX1

Klasse H  
VC3211HX1

INCLUSIEF  
1 SET ACCESSOIRES



Automatische filterreininging  
zonder zuigkrachtonderbreking.

Automatische filterreininging  
zonder zuigkrachtonderbreking.

STOFZUIGERS L- EN M-KLASSE

Klasse M  
VC2211MX1

Klasse L  
VC4210LX

Klasse M  
VC4210MX

INCLUSIEF  
1 SET ACCESSOIRES



Automatische filterreininging  
zonder zuigkrachtonderbreking.

Automatische filterreininging  
zonder zuigkrachtonderbreking.

Automatische filterreininging  
zonder zuigkrachtonderbreking.



	VC2000L	VC2012L	VC2512L	VC3011L	VC3012L	VC3012M	VC2211MX1
Nominaal vermogen	1000 W	1100 W	1100 W	1000 W	1200 W	1200 W	1050 W
Max. debiet	3,6 m <sup>3</sup> /min	3,6 m <sup>3</sup> /min	3,6 m <sup>3</sup> /min	3,6 m <sup>3</sup> /min	3,7 m <sup>3</sup> /min	3,7 m <sup>3</sup> /min	3,5 m <sup>3</sup> /min
Max. onderdruk	210 mbar	210 mbar	210 mbar	210 mbar	230 mbar	230 mbar	220 mbar
Bruto kuipvolume	20 l	19 l	23 l	30 l	30 l	30 l	22 l
Gewicht	7,5 kg	7,3 kg	6,3 kg	10,5 kg	10 kg	10 kg	16,3 kg
Prijs in €	excl. btw	€ 175,00	€ 235,00	€ 205,00	€ 269,00	€ 569,00	€ 749,00
	incl. btw	€ 211,75	€ 284,35	€ 248,05	€ 325,49	€ 688,49	€ 906,29

	VC2510LX1	VC3210LX1	VC3211MX1	VC3211HX1	VC4210LX	VC4210MX	
Nominaal vermogen	1050 W	1050 W	1050 W	1050 W	1200 W	1200 W	
Max. debiet	3,5 m <sup>3</sup> /min	3,5 m <sup>3</sup> /min	3,5 m <sup>3</sup> /min	3,5 m <sup>3</sup> /min	4,5 m <sup>3</sup> /min	4,5 m <sup>3</sup> /min	
Max. onderdruk	220 mbar	220 mbar	220 mbar	220 mbar	250 mbar	250 mbar	
Bruto kuipvolume	32 l	40 l	40 l	40 l	42 l	42 l	
Gewicht	10,5 kg	14,5 kg	16,9 kg	16,9 kg	15 kg	15 kg	
Prijs in €	excl. btw	€ 469,00	€ 549,00	€ 799,00	€ 835,00	€ 669,00	€ 759,00
	incl. btw	€ 567,49	€ 664,29	€ 966,79	€ 1.010,35	€ 809,49	€ 918,39

BOORHAMERS SDS-PLUS 2 FUNCTIES



HR1841FJ

HR2800



	HR2600	HR1841FJ	HR2800
Nominaal vermogen	800 W	470 W	800 W
Slagenergie	2,4 J	1,4 J	2,8 J
Max. Ø beton	26 mm	18 mm	28 mm
AVT	-	✓	-
Vibratieniveau hamerboren	15,5 m/s <sup>2</sup>	7,5 m/s <sup>2</sup>	20 m/s <sup>2</sup>
Gewicht	2,8 kg	2,5 kg	3,4 kg
Prijs in €	excl. btw	€ 189,00	€ 165,00
	incl. btw	€ 228,69	€ 199,65

COMBIHAMERS SDS-PLUS 3 FUNCTIES



HR2630X7

Inclusief automatische boorkop bij HR2630X7

Inclusief Boor- en beitelset 17 stuks bij HR2630TX12 & HR2631FT12 t.w.v. € 48,50



HR2631FT12



HR2470

	HR2470	HR2630X7	HR2630TX12	HR2631FT12	HR2811FT
Nominaal vermogen	780 W	800 W	800 W	800 W	800 W
Slagenergie	2,4 J	2,4 J	2,4 J	2,4 J	2,9 J
Max. Ø beton	24 mm	26 mm	26 mm	26 mm	28 mm
AVT	-	-	-	✓	-
Vibratieniveau hamerboren	15,5 m/s <sup>2</sup>	15 m/s <sup>2</sup>	15 m/s <sup>2</sup>	11,5 m/s <sup>2</sup>	15 m/s <sup>2</sup>
Gewicht	3,0 kg	3,0 kg	2,9 kg	3,0 kg	3,6 kg
Prijs in €	excl. btw	€ 185,00	€ 185,00	€ 285,00	€ 375,00
	incl. btw	€ 223,85	€ 223,85	€ 308,55	€ 344,85

COMBIHAMERS SDS-PLUS MET STOFAFZUIGING



Inclusief boor- en beitelset 17 stuks bij HR2651TX12 t.w.v. € 48,50



Inclusief stofafzuigingsunit DX11 bij HR3012FCWJ



HR2651TX12

HR3012FCWJ

	HR2651TX12	HR3012FCWJ
Nominaal vermogen	800 W	1050 W
Slagenergie	2,2 J	3,9 J
Max. Ø beton	26 mm	30 mm
AVT	✓	✓
Vibratieniveau hamerboren	11,5 m/s <sup>2</sup>	9,5 m/s <sup>2</sup>
Gewicht	4,2 kg	4,4 kg
Prijs in €	excl. btw	€ 315,00
	incl. btw	€ 381,15

COMBIHAMERS SDS-PLUS



HR3210FCT

HR3210FCT:  
met anti-vibratie  
handgreep

**INCLUSIEF**  
1 automatische  
boorkop (194568-7)  
bij HR3210FCT



		HR3200C	HR3210FCT
Nominaal vermogen		850 W	850 W
Slagenergie		5,1 J	4,9 J
Max. Ø beton		32 mm	32 mm
AVT		-	✓
Vibratieniveau hamerboren		18 m/s <sup>2</sup>	10 m/s <sup>2</sup>
Gewicht		4,8 kg	5,4 kg
Prijs in €	excl. btw	€ 509,00	€ 609,00
	incl. btw	€ 615,89	€ 736,89

COMBIHAMERS SDS-MAX



gratis 5-delige  
boor- en beitelse  
P-52445 bij HR4013C, HR4511C  
en HR5212C  
t.w.v. € 149,00



HR4013CV

**CV-modellen**  
inclusief  
stofafzuigset

		HR3541FCX	HR4013C	HR4013CV	HR4511C	HR4511CV	HR5212C
Nominaal vermogen		850 W	1100 W	1100 W	1350 W	1350 W	1500 W
Slagenergie		5,7 J	8,0 J	8,0 J	9,4 J	9,4 J	18,9 J
Max Ø beton		35 mm	40 mm	40 mm	45 mm	45 mm	52 mm
AVT		✓	✓	✓	✓	✓	✓
Vibratieniveau hamerboren		11 m/s <sup>2</sup>	5,0 m/s <sup>2</sup>	5,0 m/s <sup>2</sup>	7,5 m/s <sup>2</sup>	7,5 m/s <sup>2</sup>	12,5 m/s <sup>2</sup>
Gewicht		5,6 kg	6,8 kg	6,8 kg	8,8 kg	8,8 kg	12,1 kg
Prijs in €	excl. btw	€ 649,00	€ 759,00	€ 785,00	€ 885,00	€ 929,00	€ 979,00
	incl. btw	€ 785,29	€ 918,39	€ 949,85	€ 1.070,85	€ 1.124,09	€ 1.184,59

STOFZUIGSET VOOR BOOR-EN BREEKHAMERS

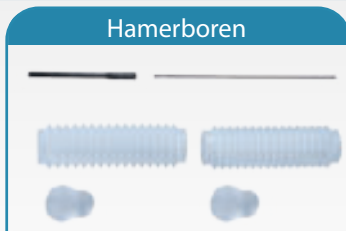

Hamerboren



Beitelen



		199142-6	195866-2	196858-4
		HR4013C	HR4511C	HR5212C
Prijs in €	excl. btw	€ 95,00	€ 103,60	€ 88,00
	incl. btw	€ 115,00	€ 125,40	€ 106,50

BIKHAMERS SDS-PLUS



HK1820

	HK0500	HK1820	
Nominaal vermogen	550 W	550 W	
Slagfrequentie	2000-3500 /min	0-3200 /min	
Slagenergie	1,8 J	3,1 J	
AVT	-	-	
Triaxiale vibratiewaarde (ah)	9,5 m/s <sup>2</sup>	10 m/s <sup>2</sup>	
Gewicht	3,2 kg	3,4 kg	
Prijs in €	excl. btw	€ 335,00	€ 529,00
	incl. btw	€ 405,35	€ 640,09

BREEKHAMERS SDS-MAX



HM1213C



HM1214C



HM0871C

**PROMO**  
gratis 5-delige  
beitelset  
E-20236 bij  
HM0871C

Wist u dat u tijdens de garantieperiode recht hebt op één gratis onderhoudsbeurt? Ontdek er meer over op [www.makita.be](http://www.makita.be)

**AVT**  
ANTI VIBRATION TECHNOLOGY

**SOFT NO LOAD**

**CV-modellen**  
inclusief  
stofafzuigset

	HM0870C	HM0871C	HM1101C	HM1101CV	
Nominaal vermogen	1100 W	1100 W	1300 W	1300 W	
Slagfrequentie	1100-2650 /min	1100-2650 /min	1100-2600 /min	1100-2600 /min	
Slagenergie	7,6 J	8,1 J	11,5 J	11,5 J	
AVT	-	✓	-	-	
Triax. vibratie beitelen (ah)	11,5 m/s <sup>2</sup>	8 m/s <sup>2</sup>	13,5 m/s <sup>2</sup>	13,5 m/s <sup>2</sup>	
Gewicht	5,1 kg	5,8 kg	7 kg	7 kg	
Prijs in €	excl. btw	€ 379,00	€ 445,00	€ 549,00	€ 569,00
	incl. btw	€ 458,59	€ 538,45	€ 664,29	€ 688,49

	HM1111C	HM1203C	HM1213C	HM1214C	
Nominaal vermogen	1300 W	1510 W	1510 W	1510 W	
Slagfrequentie	1100-2600 /min	950-1900 /min	950-1900 /min	950-1900 /min	
Slagenergie	11,2 J	19,1 J	18,6 J	19,9 J	
AVT	✓	-	✓	✓	
Triax. vibratie beitelen (ah)	8 m/s <sup>2</sup>	15,5 m/s <sup>2</sup>	7 m/s <sup>2</sup>	8 m/s <sup>2</sup>	
Gewicht	7,7 kg	9,7 kg	10,8 kg	12,3 kg	
Prijs in €	excl. btw	€ 599,00	€ 619,00	€ 679,00	€ 799,00
	incl. btw	€ 724,79	€ 748,99	€ 821,59	€ 966,79

STOFAFZUIGING BREEKHAMERS



199144-2



197168-2

		199144-2	197168-2
Prijs in €	excl. btw	€ 52,40	€ 51,30
	incl. btw	€ 63,40	€ 62,10

**SOFT  
NO LOAD**

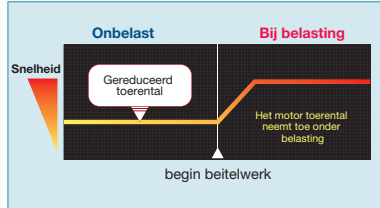

Reduceert automatisch het toerental van de machine om ongewenste trillingen verder te reduceren.

BREEKHAMERS MET ZESKANTOPNAME



**SOFT  
NO LOAD**      **AVT**  
ANTI VIBRATION TECHNOLOGY

**HM1511/HM1512:**  
slagenergie  
48,9 J



HM1812

**HM1812:**  
slagenergie 72,8 J

**GRATIS**  
trolley D-54972  
bij HM1812



HM1511

**HM1511 / HM1512 :**  
Uitzonderlijk laag trillings-  
niveau door anti-vibratie behuizing,  
actieve trillingsdemping en de  
soft-no-load regeling



	HM1317C	HM1511	HM1512	HM1812
Nominaal vermogen	1510 W	1850 W	1850 W	2000 W
Slagfrequentie	730-1450 /min	1300 /min	1300 /min	870 /min
Slagenergie	25 J	48,9 J	48,9 J	72,8 J
AVT	✓	✓	✓	✓
Triax. vibratie beetelen (ah)	8,5 m/s <sup>2</sup>	6,5 m/s <sup>2</sup>	6,5 m/s <sup>2</sup>	6,5 m/s <sup>2</sup>
Opname hex.	30 mm	30 mm	28,6 mm	28,6 mm
Gewicht	17 kg	19,2 kg	20,4 kg	31,3 kg
Prijs in €	excl. btw	€ 1.019,00	€ 1.189,00	€ 1.239,00
	incl. btw	€ 1.232,99	€ 1.438,69	€ 1.499,19



KLOPBOORMACHINES



HP2071FJ



	HP1631KSP	HP2051FHJ	HP2071FJ	
Nominaal vermogen	710 W	720 W	1010 W	
Toerental	0-3200 t.p.m.	0-2900 t.p.m.	0-2900 t.p.m.	
Ø Max. staal	13 mm	13 mm	18 mm	
Ø Max. hout	30 mm	40 mm	40 mm	
Ø Max. steen	16 mm	20 mm	20 mm	
Boorkop	1,5-13 mm	1,5-13 mm	1,5-13 mm	
Makpac	-	✓	✓	
Gewicht	2 kg	2,5 kg	2,6 kg	
Prijs in €	excl. btw	€ 125,00	€ 179,00	€ 219,00
	incl. btw	€ 151,25	€ 216,59	€ 264,99

BOORMACHINES



DP4011

DP4011  
Met 2 snelheden

	DP2011	DP4003	DP4011	
Nominaal vermogen	370 W	750 W	720 W	
Toerental	0-4200 t.p.m.	0-700 t.p.m.	0-2900 t.p.m.	
Ø Max. staal	6,5 mm	13 mm	13 mm	
Ø Max. hout	15 mm	38 mm	40 mm	
Boorkop	0,8-6,5 mm	1,5-13 mm	1,5-13 mm	
Gewicht	1,1 kg	2,4 kg	2,3 kg	
Prijs in €	excl. btw	€ 125,00	€ 285,00	€ 185,00
	incl. btw	€ 151,25	€ 344,85	€ 223,85

DIAMANTKERNBOORMACHINES



DBM131W

DBM131W / DBM230W  
Geleverd met boorstandaard



	DBM131	DBM131W	DBM230W	
Nominaal vermogen	1700 W	1700 W	2500 W	
Toerental onbelast 1	1100 t.p.m.	1100 t.p.m.	390 t.p.m.	
Toerental onbelast 2	2300 t.p.m.	2300 t.p.m.	1040 t.p.m.	
Toerental onbelast 3	-	-	1700 t.p.m.	
Ø Max. beton	132 mm	132 mm	230 mm	
Gewicht	6,1 kg	6,1 kg	6,9 kg	
Prijs in €	excl. btw	€ 725,00	€ 1.199,00	€ 2.289,00
	incl. btw	€ 877,25	€ 1.450,79	€ 2.769,69

ACCESSOIRES

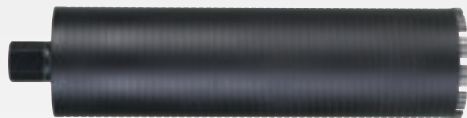

Diamantboren

Nieuwe beton diamantkernboren voor nat gebruik.

- Langere levensduur dankzij lasergelaste segmenten.
- Totale lengte verhoogd naar 450mm.
- Snellere boorprestatie dankzij chevron-vormige diamantdeeltjes.

Omschrijving	Best. nr..	Ø	Lengte	Opname	Stuks	Prijs excl. btw	Prijs incl. btw
Diamantkernboor	E-19869	32 mm	450 mm	1-1/4"UNC	1	€ 121.50	€ 147.02
Diamantkernboor	E-19875	42 mm	450 mm	1-1/4"UNC	1	€ 135.50	€ 163.96
Diamantkernboor	E-19881	52 mm	450 mm	1-1/4"UNC	1	€ 154.00	€ 186.34
Diamantkernboor	E-19897	62 mm	450 mm	1-1/4"UNC	1	€ 175.50	€ 212.36
Diamantkernboor	E-19906	68 mm	450 mm	1-1/4"UNC	1	€ 199.50	€ 241.40
Diamantkernboor	E-19912	72 mm	450 mm	1-1/4"UNC	1	€ 206.50	€ 249.87
Diamantkernboor	E-19928	82 mm	450 mm	1-1/4"UNC	1	€ 226.50	€ 274.07
Diamantkernboor	E-19934	92 mm	450 mm	1-1/4"UNC	1	€ 262.50	€ 317.63
Diamantkernboor	E-19940	102 mm	450 mm	1-1/4"UNC	1	€ 269.00	€ 325.49
Diamantkernboor	E-19956	107 mm	450 mm	1-1/4"UNC	1	€ 289.50	€ 350.30
Diamantkernboor	E-19962	112 mm	450 mm	1-1/4"UNC	1	€ 300.00	€ 363.00

Omschrijving	Best. nr..	Ø	Lengte	Opname	Stuks	Prijs excl. btw	Prijs incl. btw
Diamantkernboor	E-19978	117 mm	450 mm	1-1/4"UNC	1	€ 305.00	€ 369.05
Diamantkernboor	E-19984	122 mm	450 mm	1-1/4"UNC	1	€ 321.00	€ 388.41
Diamantkernboor	E-19990	127 mm	450 mm	1-1/4"UNC	1	€ 371.00	€ 448.91
Diamantkernboor	E-20002	132 mm	450 mm	1-1/4"UNC	1	€ 380.00	€ 459.80
Diamantkernboor	E-20018	142 mm	450 mm	1-1/4"UNC	1	€ 395.00	€ 477.95
Diamantkernboor	E-20024	152 mm	450 mm	1-1/4"UNC	1	€ 423.00	€ 511.83
Diamantkernboor	E-20030	162 mm	450 mm	1-1/4"UNC	1	€ 438.50	€ 530.59
Diamantkernboor	E-20046	172 mm	450 mm	1-1/4"UNC	1	€ 510.50	€ 617.71
Diamantkernboor	E-20052	182 mm	450 mm	1-1/4"UNC	1	€ 532.00	€ 643.72
Diamantkernboor	E-20068	202 mm	450 mm	1-1/4"UNC	1	€ 600.00	€ 726.00
Diamantkernboor	E-20074	212 mm	450 mm	1-1/4"UNC	1	€ 745.00	€ 901.45

HAAKSE BOORMACHINES



		DA3010FJ	DA3011FJ
Nominaal vermogen		450 W	450 W
Toerental		0-2400 t.p.m.	0-2400 t.p.m.
Ø Max. staal		10 mm	10 mm
Ø Max. hout		25 mm	25 mm
Boorkop		1-10 mm	1-10 mm
Gewicht		1,6 kg	1,6 kg
Prijs in €	excl. btw	€ 295,00	€ 295,00
	incl. btw	€ 356,95	€ 356,95

KERNBOORMACHINE MET MAGNEETVOET



		HB350	HB500
Nominaal vermogen		1050 W	1150 W
Toerental onbelast 1		450 t.p.m.	350 t.p.m.
Toerental onbelast 2		850 t.p.m.	650 t.p.m.
Ø Max. staal		35 mm	50 mm
Klemkracht magneetvoet		8000 N	9300 N
Opname		3/4" WELDON	3/4" WELDON
Gewicht		11,5 kg	18,5 kg
Prijs in €	excl. btw	€ 729,00	€ 1.349,00
	incl. btw	€ 882,09	€ 1.632,29

MENGERS



UT1600

		UT1400	UT1401	UT1600
Nominaal vermogen		1300 W	1300 W	1800 W
Toerental onbelast 1		0-900 t.p.m.	0-400 t.p.m.	0-440 t.p.m.
Toerental onbelast 2		-	0-730 t.p.m.	0-970 t.p.m.
Toerental belast max.		0-580 t.p.m.	0-450 t.p.m.	0-580 t.p.m.
Schroefdraad spindel		M14	M14	M14
Gewicht		5,2 kg	5,5 kg	7,1 kg
Prijs in €	excl. btw	€ 309,00	€ 355,00	€ 435,00
	incl. btw	€ 373,89	€ 429,55	€ 526,35

BOORMACHINE / MENER



		DS4012
Nominaal vermogen		750 W
Toerental		600 t.p.m.
Ø Max. staal		13 mm
Ø Max. hout		36 mm
Boorkop		2-13 mm
Gewicht		2,8 kg
Prijs in €	excl. btw	€ 245,00
	incl. btw	€ 296,45

SCHROEFAUTOMATEN



6843J

		6844	6843J
Nominaal vermogen		470 W	470 W
Toerental		3000 t.p.m.	6000 t.p.m.
Ø gipsplaatschroef		3,5 - 4,0 mm	3,5 - 4,0 mm
Schroeflengte		45-75 mm	25-55 mm
Verpakking		Koffer	Makpac
Gewicht		2 kg	2 kg
Prijs in €	excl. btw	€ 399,00	€ 405,00
	incl. btw	€ 482,79	€ 490,05

SCHROEFMACHINES VOOR GIPSPLAAT



FS2500K: met 1/4" Hex bitopname



FS2500



FS2701K

FS2701K: met koppelinstelling (6 stappen)



schroeflintadapter 191L24-0

		FS2300K	FS2500K	FS2701K	FS4000JX2	FS6300RJX2
Nominaal vermogen		570 W	570 W	570 W	570 W	570 W
Toerental		0-2500 t.p.m.	0-2500 t.p.m.	0-2500 t.p.m.	0-4000 t.p.m.	0-6000 t.p.m.
Ø gipsplaatschroef		5 mm	5 mm	5 mm	5 mm	5 mm
Incl. schroeflintadapter		-	-	-	✓	✓
Gewicht		1,7 kg	1,6 kg	1,7 kg	1,3 kg	1,4 kg
Prijs in €	excl. btw	€ 175,00	€ 215,00	€ 249,00	€ 199,00	€ 209,00
	incl. btw	€ 211,75	€ 260,15	€ 301,29	€ 240,79	€ 252,89

HETELUCHTPISTOLEN



HG6531CK



HG5030K

	HG5030K	HG6031VK	HG6531CK
Vermogen	1600 W	1800 W	2000 W
Temperatuurbereik	350-500 °C	50-600 °C	50-650 °C
Temperatuurinstelling	2 niveaus	9 niveaus	Elektronisch in stappen van 5°C
Debiet	300 / 500 l/min	250 / 500 l/min	200 / 550 l/min
Gewicht	0,56 kg	0,67 kg	0,71 kg
Prijs in €	excl. btw	€ 79,00	€ 105,00
	incl. btw	€ 95,59	€ 127,05

SLAGMOERSLEUTELS



TW0200J  
TW0350J  
6906J

TW0350J

	TW0200J	TW0350J	6906J	TW1000
Nominaal vermogen	380 W	400 W	650 W	1300 W
Max. koppel	200 Nm	350 Nm	588 Nm	1000 Nm
Bitopname	1/2" vierkant	1/2" vierkant	3/4" vierkant	1" vierkant
Gewicht	2,2 kg	3 kg	5,6 kg	8,6 kg
Prijs in €	excl. btw	€ 325,00	€ 385,00	€ 619,00
	incl. btw	€ 393,25	€ 465,85	€ 748,99

KNABELSCHAREN



JN3201J

	JN1601	JN3201J
Nominaal vermogen	550 W	710 W
Max. dikte staal	1,6 mm	3,2 mm
Gewicht	1,6 kg	3,4 kg
Prijs in €	excl. btw	€ 395,00
	incl. btw	€ 477,95

PLAATSCHAREN



JS1602J

	JS1601J	JS1602J	JS3201J
Nominaal vermogen	380 W	380 W	710 W
Aantal zaagbewegingen	4500 /min	4000 /min	1600 /min
Max. dikte staal	1,6 mm	1,6 mm	3,2 mm
Gewicht	1,4 kg	1,6 kg	3,4 kg
Prijs in €	excl. btw	€ 355,00	€ 489,00
	incl. btw	€ 429,55	€ 591,69

METAALCIRKELZAAG



4131

	4131	
Nominaal vermogen	1100 W	
Toerental	3500 t.p.m.	
Zaagdiepte (90°)	63 mm	
Ø Zaagblad	185 mm	
Gewicht	5,1 kg	
Prijs in €	excl. btw	€ 445,00
	incl. btw	€ 538,45

GROEFFREES



Voor aluminium /  
composiet platen

	CA5000XJ	
Nominaal vermogen	1300 W	
Toerental	2200-6400 t.p.m.	
Ø Zaagblad	118 mm	
Gewicht	5,1 kg	
Prijs in €	excl. btw	€ 599,00
	incl. btw	€ 724,79

COMFORTABEL WERKEN MET SUPER JOINT SYSTEM II

Zonder SJS

Kogellager

Kegeltandwiel in tandwielhuis

Spindel

Kogellager

Meeneem-nok (op spindel geperst)

Bladveer

Kegeltandwiel in tandwielhuis

Spindel

Bladveer absorbeert trillingen en vermindert schokken tijdens het werken

HAAKSE SLIJPER 125 MM

GA5034

		GA5034	GA5030RK	GA5030RSP2
Nominaal vermogen		720 W	720 W	720 W
Toerental		11000 t.p.m.	11000 t.p.m.	11000 t.p.m.
Ø schijf		125 mm	125 mm	125 mm
Dodemansschakelaar		✓	-	-
Gewicht		1,9 kg	1,8 kg	1,8 kg
Prijs in €	excl. btw	€ 99,00	€ 95,00	€ 119,00
	incl. btw	€ 119,79	€ 114,95	€ 143,99

HAAKSE SLIJPER 115 MM

GA4530RK

		GA4530RK
Nominaal vermogen		720 W
Toerental		11000 t.p.m.
Ø schijf		115 mm
Gewicht		1,8 kg
Prijs in €	excl. btw	€ 89,00
	incl. btw	€ 107,69

HAAKSE SLIJPER 125 MM

9558HNRGK3

9558HNRGK3:  
geleverd met  
1 afbraamschijf en  
2 diamantschijven

125 MM

9558PBGY met dodemansschakelaar: motor schakelt uit bij loslaten van schakelaar voor verhoogde veiligheid

		9558HNRGZ	9558PBGY	9558HNRGK3
Nominaal vermogen		840 W	840 W	840 W
Toerental		11000 t.p.m.	11000 t.p.m.	11000 t.p.m.
Ø schijf		125 mm	125 mm	125 mm
Dodemansschakelaar		-	✓	-
Gewicht		2,1 kg	2,1 kg	2,1 kg
Prijs in €	excl. btw	€ 99,00	€ 99,00	€ 129,00
	incl. btw	€ 119,79	€ 119,79	€ 156,09

HAAKSE SLIJPER 125 MM X-LOCK



**X-LOCK**  
Snel en veilig schijven bevestigen via een kliksysteem.



GA5080RX03

**GA5080RX03**

Nominaal vermogen	1400 W	
Toerental	12000 t.p.m.	
Ø schijf	125 mm	
Verpakking	Makpac	
Gewicht	2,5 – 3,6 kg	
Prijs in €	excl. btw	€ 199,00
	incl. btw	€ 240,79

HAAKSE SLIJPERS 125 MM



GA5041CT01

GA5040CJD1



**GA5041CT01**  
met mechanische motorrem,  
instelbaar toerental, Ezynut & AVT-grip

**SA5040C Traagdraaiend**

	GA5040RZ	GA5040RKDJ	GA5040C	GA5040CJD	GA5040CJD1	GA5041RZ	GA5041CT01	SA5040C	
Nominaal vermogen	1100 W	1100 W	1400 W	1400 W	1400 W	1100 W	1400 W	1400 W	
Toerental	11000 t.p.m.	11000 t.p.m.	2800-11000 t.p.m.	2800-11000 t.p.m.	2800-11000 t.p.m.	11000 t.p.m.	2700-11000 t.p.m.	2000-7800 t.p.m.	
Heropstartbeveiliging	✓	✓	✓	✓	✓	✓	✓	✓	
Mechanische rem	-	-	-	-	-	✓	✓	-	
Type schakelaar	Schuifschakelaar met vergrendeling	Schuifschakelaar met vergrendeling	Schuifschakelaar met vergrendeling	Schuifschakelaar met vergrendeling	Schuifschakelaar met vergrendeling	Schuifschakelaar met vergrendeling	Schuifschakelaar met vergrendeling	Schuifschakelaar met vergrendeling	
Verpakking	Karton	Makpac	Karton	Makpac	Makpac	Karton	Karton	Karton	
Gewicht	2,4 kg	2,4 kg	2,4 kg	2,4 kg	2,7 kg	2,4 kg	2,7 kg	2,2 kg	
Meegeleverde accessoires	-	2 x diamantschijf	-	2 x diamantschijf	1 x diamantschijf + beschermkap stofafzuiging	-	AVT-greep + Ezynut sluitmoer	-	
Prijs in €	excl. btw	€ 139,00	€ 175,00	€ 179,00	€ 215,00	€ 245,00	€ 199,00	€ 225,00	€ 249,00
	incl. btw	€ 168,19	€ 211,75	€ 216,59	€ 260,15	€ 296,45	€ 240,79	€ 272,25	€ 301,29

HAAKSE SLIJPERS 125 MM / 150 MM



9565PCV01

9565PCV01 & 9566PCV01: Antivibratiehandgreep en dodemansschakelaar.



GA5050R: grote lepelschakelaar + gereedschapsloze beschermkap

	GA5050R	9565CRX1	9565PCV01	9566PCV01	GA6040C	
Nominaal vermogen	1300 W	1400 W	1400 W	1400 W	1400 W	
Toerental	11000 t.p.m.	11000 t.p.m.	2800-11500 t.p.m.	4000-10000 t.p.m.	4000-9000 t.p.m.	
SJS	-	✓	✓	✓	✓	
Ø schijf	125 mm	125 mm	125 mm	150 mm	150 mm	
Type schakelaar	Lepelschakelaar zonder vergrendeling	Schuifschakelaar met vergrendeling	Lepelschakelaar zonder vergrendeling	Lepelschakelaar zonder vergrendeling	Schuifschakelaar met vergrendeling	
Gewicht	2,5 kg	2,6 kg	2,6 kg	2,7 kg	2,6 kg	
Prijs in €	excl. btw	€ 149,00	€ 149,00	€ 159,00	€ 205,00	€ 199,00
	incl. btw	€ 180,29	€ 180,29	€ 192,39	€ 248,05	€ 240,79

HAAKSE SLIJPERS 125 MM



GA5021CY

GA5021CYX1: Inclusief antivibratiegreep en Ezynut sluitmoer

	GA5021C	GA5021CY	GA5021CYX1	
Nominaal vermogen	1450 W	1450 W	1450 W	
Toerental	10000 t.p.m.	10000 t.p.m.	10000 t.p.m.	
Ø schijf	125 mm	125 mm	125 mm	
Dodemansschakelaar	-	✓	✓	
Gewicht	3 kg	3 kg	3 kg	
Prijs in €	excl. btw	€ 209,00	€ 209,00	€ 235,00
	incl. btw	€ 252,89	€ 252,89	€ 284,35

**10x**  
Doorslijpschijven  
in blik



Ref.	Ø (mm)	Dikte (mm)	Ø asgat (mm)	Prijs	
				excl. btw	incl. btw
D-18770-10	125	1,2	22,23	€ 13,90	€ 16,82

HAAKSE SLIJERS 125 MM

- Bestand tegen langdurige hoge belasting dankzij verbeterde koeling
- Greepomtrek van slechts 205 mm
- Mechanische rem (GA5091, GA5093, GA5094)
- De AFT functie stopt de motor ogenblikkelijk wanneer de schijf blokkeert



	GA5092X01	GA5090X01	GA5091X01	GA5095X01	GA5094	GA5093X01
Nominaal vermogen	1900 W	1900 W	1900 W	1900 W	1900 W	1900 W
Toerental	11500 min <sup>-1</sup>	2800-11500 min <sup>-1</sup>	2800-11500 min <sup>-1</sup>	11500 min <sup>-1</sup>	11500 min <sup>-1</sup>	2800-11500 min <sup>-1</sup>
Variabel toerental	-	✓	✓	-	-	✓
Mechanische rem	-	-	✓	-	✓	✓
Type Schakelaar	Schuifschakelaar	Schuifschakelaar	Schuifschakelaar	Lepelschakelaar	Lepelschakelaar	Lepelschakelaar
Dodemansschakelaar	-	-	-	✓	✓	✓
Gewicht	2,6 - 3,8 kg	2,6 - 3,8 kg	2,8 - 4,0 kg	2,7 - 3,8 kg	2,9 - 4,0 kg	2,9 - 4,0 kg
Prijs in €	excl. btw	€ 189,00	€ 209,00	€ 229,00	€ 199,00	€ 239,00
	incl. btw	€ 228,69	€ 252,89	€ 277,09	€ 240,79	€ 289,19

ACCESSOIRES

	Omschrijving	Artikel	Diameter	Dikte	Asgat	Reductiering	Specificatie	Hoogte segment	Verpakkings-eenheid	Prijs excl. btw	Prijs incl. btw
	Doorslijpschijf staal	P-53023	125 mm	1,0 mm	22,23 mm		A60R-BF		1	€ 2,20	€ 2,66
	Doorslijpschijf inox	P-53045	125 mm	1,0 mm	22,23 mm		A60S-BF		1	€ 2,20	€ 2,66
	Doorslijpschijf inox 'Fast cutting'	B-45733	125 mm	0,8 mm	22,23 mm		Z60T-BF		1	€ 2,40	€ 2,90
	Doorslijpschijf inox 'Fast cutting'	B-45733-12	125 mm	0,8 mm	22,23 mm		Z60T-BF		12	€ 28,00	€ 33,88
	Diamantschijf Comet	B-12778	125 mm	2,0 mm	22,23 mm	20 mm		10 mm	1	€ 52,40	€ 63,40
	Doorslijpschijf staal	P-05773	230 mm	2,5 mm	22,23 mm		A30S4-BF		1	€ 3,10	€ 3,75
	Doorslijpschijf inox	E-13764	230 mm	1,9 mm	22,23 mm		A60U-BF		1	€ 5,50	€ 6,66
	Diamantschijf Comet	B-12784	230 mm	2,6 mm	22,23 mm			10 mm	1	€ 119,20	€ 144,23

HAAKSE SLIJERS 180 MM



	GA7050	GA7060	GA7082	GA7070X1	GA7070YX1	
Nominaal vermogen	2000 W	2200 W	2800 W	2800 W	2800 W	
Toerental	8500 t.p.m.	8500 t.p.m.	8500 t.p.m.	8500 t.p.m.	8500 t.p.m.	
Dodemansschakelaar	✓	✓	-	-	✓	
Draaibare achterhandgreep	-	-	-	✓	✓	
Mechanische rem	-	-	-	✓	✓	
Gewicht	4,5 kg	5,3 kg	6,0 kg	6,2 - 6,7 kg	6,1 - 6,6 kg	
Prijs in €	excl. btw	€ 129,00	€ 149,00	€ 155,00	€ 299,00	€ 319,00
	incl. btw	€ 156,09	€ 180,29	€ 187,55	€ 361,79	€ 385,99

HAAKSE SLIJPERS 230 MM



GA9061R



GA9082



GA9060KD

Incl. diamantschijf

		GA9050	GA9060	GA9060KD	GA9082	GA9061R
Nominaal vermogen		2000 W	2200 W	2200 W	2700 W	2200 W
Toerental		6600 t.p.m.	6600 t.p.m.	6600 t.p.m.	6600 t.p.m.	6600 t.p.m.
Soft start		-	-	-	✓	✓
Dodemansschakelaar		✓	✓	✓	-	-
Draaibare achterhandgreep		-	-	-	-	-
Heropstartbeveiliging		-	-	-	-	✓
Gewicht		4,7 kg	5,6 kg	5,6 kg	6,1 kg	5,7 kg
Prijs in €	excl. btw	€ 135,00	€ 159,00	€ 179,00	€ 165,00	€ 209,00
	incl. btw	€ 163,35	€ 192,39	€ 216,59	€ 199,65	€ 252,89



HAAKSE SLIJPERS 230 MM



GA9040RF01



GA9030SF01



GA9070YX1



GA9071YX1:  
Met gesloten handgreep

		GA9030SF01	GA9030RF01	GA9040SF01	GA9040RF01	GA9080X1	GA9070X1	GA9070YX1	GA9071X1	GA9071YX1
Nominaal vermogen		2400 W	2400 W	2600 W	2600 W	2700 W	2800 W	2800 W	2800 W	2800 W
Toerental		6600 t.p.m.	6600 t.p.m.	6600 t.p.m.	6600 t.p.m.	6600 t.p.m.	6600 t.p.m.	6600 t.p.m.	6600 t.p.m.	6600 t.p.m.
Dodemansschakelaar		✓	-	✓	-	-	-	✓	-	✓
Draaibare achterhandgreep		✓	✓	✓	✓	✓	✓	✓	✓	✓
Antivibratie zijhandgreep		✓	✓	✓	✓	-	✓	✓	✓	✓
Soft start		✓	✓	✓	✓	✓	✓	✓	✓	✓
Heropstartbeveiliging		-	✓	-	✓	✓	✓	✓	✓	✓
Mechanische rem		-	-	-	-	-	✓	✓	✓	✓
Gewicht		6,3 kg	6,5 kg	6,7 kg	6,9 kg	6,4 kg	6,3 kg	6,3 - 8,5 kg	6,4 kg	6,3 - 8,5 kg
Prijs in €	excl. btw	€ 209,00	€ 209,00	€ 219,00	€ 219,00	€ 259,00	€ 315,00	€ 335,00	€ 315,00	€ 335,00
	incl. btw	€ 252,89	€ 252,89	€ 264,99	€ 264,99	€ 313,39	€ 381,15	€ 405,35	€ 381,15	€ 405,35

STEMPELSLIJERS



GS5000



GD0810C



GD0811C



GD0603

	GD0600	GD0603	GD0800C	GD0810C	GD0801C	GD0811C	GS5000	
Nominaal vermogen	400 W	240 W	750 W	750 W	750 W	750 W	750 W	
Toerental	25000 t.p.m.	28000 t.p.m.	7000-28000 t.p.m.	1800-7000 t.p.m.	7000-28000 t.p.m.	1800-7000 t.p.m.	5600 t.p.m.	
Ø spantang - bereik	6 mm	6 mm	6-8 mm	6-8 mm	6-8 mm	6-8 mm	20 mm	
Ø spantang - inbegrepen	6 mm	6 mm	6 mm	6 mm	6 mm	6 mm	20 mm	
Lepelschakelaar	✓	-	-	-	✓	✓	-	
Dodemans	-	-	-	-	✓	✓	✓	
Gewicht	1,7 kg	0,97 kg	1,7 kg	1,7 kg	1,7 kg	2,0 kg	5,0 kg	
Prijs in €	excl. btw	€ 179,00	€ 179,00	€ 315,00	€ 335,00	€ 315,00	€ 335,00	€ 465,00
	incl. btw	€ 216,59	€ 216,59	€ 381,15	€ 405,35	€ 381,15	€ 405,35	€ 562,65

COMBOPACK SLIJERS



GA9060 125 mm  
230 mm

9558HNRG

	DK0047GX1	DK0046X1	
Haakse slijper 230 mm	GA9060	GA9061R	
Haakse slijper 125 mm	9558HNRG	GA5040RZ	
Diamantschijf	2 x Diamak DS	2 x Diamak DS	
Synthetische koffer	✓	✓	
Prijs in €	excl. btw	€ 285,00	€ 325,00
	incl. btw	€ 344,85	€ 393,25

COMBOPACK KLOPBOORMACHINE + HAAKSE SLIJER



DK0050X1

Klopboormachine 710 W	HP1631	
Haakse slijper 125 mm	GA5030R	
Borensset	D-08660	
Synthetische koffer	✓	
Prijs in €	excl. btw	€ 205,00
	incl. btw	€ 248,05

COMBOPACK SCHUURMACHINE + STOFZUIGER



DK6525

Schuurmachine	BO6050J	
Stofzuiger	VC2510LX1	
Prijs in €	excl. btw	€ 709,00
	incl. btw	€ 857,89



METAALAFKORTMACHINES

LC1230N

- Inclusief HM zaagblad
- verstekhoek instelbaar op 45°



LW1400X



LC1230N

LW1400X LC1230N

Nominaal vermogen	2200 W	1750 W	
Type schijf	doorslijpschijf	zaagblad	
Toerental	3800 t.p.m.	1300 t.p.m.	
Zaagdiepte (90°)	115 mm	100 mm	
Ø Zaagblad	355 mm	305 mm	
Gewicht	17,2 kg	19,3 kg	
Prijs in €	excl. btw	€ 355,00	€ 725,00
	incl. btw	€ 429,55	€ 877,25

BETONSCHAVEN

PC5001C  
Geleverd met komschijf B-12289



PC50001C

PC5010C

PC5010C PC5001C

Nominaal vermogen	1400 W	1400 W	
Ø schijf	125 mm	125 mm	
Gewicht	2,5 kg	5,1 kg	
Prijs in €	excl. btw	€ 335,00	€ 719,00
	incl. btw	€ 405,35	€ 869,99

PC5010C:  
Instelbaar toerental

MUURFREZEN



SG150



SG181

SG1251J SG150 SG181

Nominaal vermogen	1400 W	1800 W	2150 W	
Max. slijpdiepte	30 mm	45 mm	60 mm	
Sleufbreedte	6-30 mm	7-35 mm	7-43 mm	
Ø schijf	125 mm	150 mm	180 mm	
Gewicht	4,4 kg	5,7 kg	6 kg	
Prijs in €	excl. btw	€ 549,00	€ 829,00	€ 1.119,00
	incl. btw	€ 664,29	€ 1.003,09	€ 1.353,99

DIAMANTZAAG



4114S

Nominaal vermogen	2400 W	
Max. slijpdiepte	125 mm	
Ø schijf	350 mm	
Ø asgat	25,4 mm	
Gewicht	10,8 kg	
Prijs in €	excl. btw	€ 699,00
	incl. btw	€ 845,79

DIAMANTZAAG



4100KB

Nominaal vermogen	1400 W	
Zaagdiepte (90°)	40 mm	
Ø Zaagblad	125 mm	
Gewicht	3,0 kg	
Prijs in €	excl. btw	€ 179,00
	incl. btw	€ 216,59



MOTORDOORSLIJPERS



EK6100

		EK6100
Motor		2-takt
Cilinderinhoud		60,7 cc
Vermogen		3,2kW/4,3 pk
Maximaal nettokoppel		3,9 Nm
Ø schijf		300 mm
Decompressieklep		-
Gewicht		8,5 kg
Prijs in €	excl. btw	€ 849,00
	incl. btw	€ 1.027,29

DIAMANTSCHIJVEN

	Artikel	Ø	Dikte	Hoogte segment	Ø asgat	Reductiering	Prijs excl. btw	Prijs incl. btw
<b>Quasar</b>	 B-17588	300 mm	3,0 mm	12 mm	25,4 mm	20 mm	€ 219,40	€ 265,50
	B-13465	350 mm	3,0 mm	12 mm	25,4 mm	20 mm	€ 288,60	€ 349,20
	B-13471	400 mm	3,0 mm	12 mm	25,4 mm	20 mm	€ 335,20	€ 405,60
<b>Comet</b>	 B-17619	300 mm	3,0 mm	10 mm	25,4 mm	20 mm	€ 180,50	€ 218,40
	B-13552	350 mm	3,0 mm	10 mm	25,4 mm	20 mm	€ 215,00	€ 260,20
	B-13568	400 mm	3,0 mm	10 mm	25,4 mm	20 mm	€ 261,80	€ 316,80
<b>Asfalt</b>	 B-13275	350 mm	3,2 mm	10 mm	25,4 mm	20 mm	€ 242,80	€ 293,80
	B-42905	400 mm	3,2 mm	10 mm	25,4 mm	20 mm	€ 324,10	€ 392,20

	Artikel	Ø extern	Ø intern	Dikte	Prijs excl. btw	Prijs incl. btw
<b>Reductieringen</b>	 257199-4	22,23 mm	20,00 mm	3,0 mm	€ 4,50	€ 5,40
	197318-9	25,4 mm	20,00 mm	5 mm	€ 8,20	€ 9,90

SLIJPMOLENS



GB801



	GB602W	GB801
Nominaal vermogen	250 W	550 W
Toerental	2850 t.p.m.	2850 t.p.m.
Ø Slijpsteen	150 mm	205 mm
Gewicht	9 kg	19,8 kg
Prijs in €	excl. btw	€ 195,00
	incl. btw	€ 235,95
Prijs in €	excl. btw	€ 279,00
	incl. btw	€ 337,59

LINTZAAGMACHINE



B-42581	€ 14,60 hors TVA
Schuurbanden 20 x 2240 mm Rood • Korrel 80	€ 17,70 TVA incl.
B-42597	€ 14,60 hors TVA
Schuurbanden 20 x 2240 mm Rood • Korrel 120	€ 17,70 TVA incl.
JM21000330	€ 13,50 hors TVA
Adapterset voor schuurbanden	€ 16,30 TVA incl.

		LB1200F
Nominaal vermogen		900 W
Breedte zaaglint		6-16 mm
Gewicht		81,2 kg
Prijs in €	excl. btw	€ 815,00
	incl. btw	€ 986,15

RECIPROZAGEN



JR3070CT

		JR3051TK	JR3061T	JR3070CT
Nominaal vermogen		1200 W	1250 W	1510 W
Aantal zaagbewegingen		0-3000 /min	0-2800 /min	0-2800 /min
AVT		-	-	✓
Pendelinstelling		-	-	✓
Slaglengte		30 mm	32 mm	32 mm
Vibratieniveau		19,5 m/s <sup>2</sup>	23,5 m/s <sup>2</sup>	8,5 m/s <sup>2</sup>
Gewicht		3,2 kg	4,4 kg	4,4 kg
Prijs in €	excl. btw	€ 175,00	€ 229,00	€ 295,00
	incl. btw	€ 211,75	€ 277,09	€ 356,95

LAMELLENFREES



Revolver diepte-instelling met 6 preselecties voor een snelle afstelling.

Aanslagplaat met tandheugelverstelling voor een snelle en precieze aanpassing aan de materiaaldikte.

Kantelbare voetplaat met handige vergrendelingshendel en automatische stops op 0°, 45° en 90°.

		PJ7000J
Nominaal vermogen		700 W
Toerental		11000 t.p.m.
Ø zaagblad		100 mm
Asgat		22 mm
Gewicht		2,5 kg
Prijs in €	excl. btw	€ 319,00
	incl. btw	€ 385,99

MULTITOOL



INCLUSIEF:  
Set van 9 accessoires,  
30 schuurvellen en 1 afzuigset



GEREEDSCHAPSLOZE  
ACCESSOIREWISSEL

		TM3010CX3J
Nominaal vermogen		320 W
Oscillatiefrequentie		6000-20000/min
Oscillatiehoek		3,2°
Gewicht		1,6 kg
Prijs in €	excl. btw	€ 255,00
	incl. btw	€ 308,55

VANDIKTEBANK



		2012NB
Nominaal vermogen		1650 W
Toerental		8500 t.p.m.
Breedte		304 mm
Max. doorlaathoogte		155 mm
Max. spaanafname		3 mm
Gewicht		28,1 kg
Prijs in €	excl. btw	€ 845,00
	incl. btw	€ 1.022,45

KETTINGFREZEN



		7104L	7104L-30
Nominaal vermogen		1140 W	1140 W
Toerental		3200 t.p.m.	3200 t.p.m.
Kettingsnelheid onbelast		5 m/s	5 m/s
Ketting		16,5 mm	30 mm
Gatbreedte		16,5-30 mm	30-45 mm
Gatlengte		54-130 mm	54-130 mm
Gewicht		17,3 kg	17,3 kg
Prijs in €	excl. btw	€ 1.509,00	€ 1.649,00
	incl. btw	€ 1.825,89	€ 1.995,29

BOVENFREZEN



RP1111CJ



RP2302FC07

RP2302FC07: Inclusief langseleider met fijnafstelling

	RP0900J	RP1111CJ	RP1802F	RP2302FC07	
Nominaal vermogen	900 W	1100 W	1850 W	2300 W	
Toerental	27000 t.p.m.	8000 - 27500 t.p.m.	23000 t.p.m.	9000-22000 t.p.m.	
Max. induikdiepte	35 mm	57 mm	70 mm	70 mm	
Ø Spantang - bereik	6-8 mm	6-8 mm	6-12 mm	6-12 mm	
Ø Spantang - inbegrepen	8 mm	8 mm	6, 8, 12 mm	6, 8, 12 mm	
Verpakking	Makpac	Makpac	Karton	Makpac	
Gewicht	2,7 kg	3,3 kg	6,2 kg	6,1 kg	
Prijs in €	excl. btw	€ 229,00	€ 369,00	€ 369,00	€ 469,00
	incl. btw	€ 277,09	€ 446,49	€ 446,49	€ 567,49

KANTENFREZEN



3711



3712

3712: Inclusief kantelbare zool

	3711	3712	
Nominaal vermogen	530 W	530 W	
Toerental	32000 t.p.m.	32000 t.p.m.	
Max. induikdiepte	42 mm	42 mm	
Spantang	6 mm	6 mm	
Gewicht	1,5 kg	1,7 kg	
Prijs in €	excl. btw	€ 105,00	€ 125,00
	incl. btw	€ 127,05	€ 151,25

BOVEN- EN KANTENFREES



4 MACHINES IN 1

- Rechte kantenfrees
- Verstelbare kantenfrees
- Kantenfrees met verschoven spindel
- Bovenfrees

Rechte kantenfrees  
Regelbare freesdiepte van 0 tot 40 mm

Verstelbare kantenfrees  
Hoekinstelling tussen -30° en 45°

Kantenfrees met verschoven spindel om zo dicht mogelijk tegen een obstakel te werken

Bovenfrees  
Diepteregeling per 1/10 van een mm van 0 tot 35 mm

RT0702CX3J

Nominaal vermogen	710 W	
Toerental	10000-30000 t.p.m.	
Max. induikdiepte	35 mm	
Ø Spantang - bereik	6 - 8 mm	
Ø Spantang - inbegrepen	6 mm, 8 mm	
Gewicht	1,8 kg	
Prijs in €	excl. btw	€ 319,00
	incl. btw	€ 385,99

SCHAVEN



KP0810CJ

1100

	KP0800J	KP0810J	KP0810CJ	1100	1911BJ	1806B	KP312S
Nominaal vermogen	620 W	850 W	1050 W	950 W	900 W	1200 W	2200 W
Toerental	17000 t.p.m.	16000 t.p.m.	12000 t.p.m.	16000 t.p.m.	16000 t.p.m.	18000 t.p.m.	12000 t.p.m.
Breedte	82 mm	82 mm	82 mm	82 mm	110 mm	170 mm	312 mm
Max. spaanafname	2,5 mm	4 mm	4 mm	3 mm	2 mm	2 mm	3,5 mm
Gewicht	2,6 kg	3,3 kg	3,4 kg	5,1 kg	4,3 kg	9,0 kg	18,4 kg
Prijs in €	excl. btw	€ 225,00	€ 309,00	€ 339,00	€ 429,00	€ 369,00	€ 2.499,00
	incl. btw	€ 272,25	€ 373,89	€ 410,19	€ 519,09	€ 446,49	€ 3.023,79

DECOUPEERZAGEN



4350FCTJ



4351FCTJ



JV0600J



4329K



	4326	4329K	JV0600J	4350FCTJ	4351FCTJ
Nominaal vermogen	450 W	450 W	650 W	720 W	720 W
Aantal zaagbewegingen	3100 /min	500-3100 /min	500-3100 /min	800-2800 /min	800-2800 /min
Max. capaciteit hout	65 mm	65 mm	90 mm	135 mm	135 mm
Makpac	-	-	✓	✓	✓
Gewicht	1,8 kg	1,9 kg	2,4 kg	2,6 kg	2,5 kg
Prijs in €	excl. btw	€ 95,00	€ 115,00	€ 149,00	€ 219,00
	incl. btw	€ 114,95	€ 139,15	€ 180,29	€ 264,99

COMBOPACK

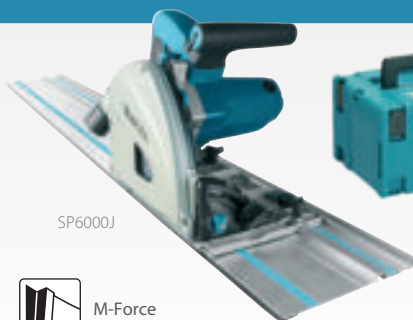

SP6000J



M-Force



4351FCTJ

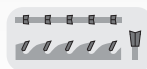

MEU029J

Invalcirkelzaag	SP6000J	
Decoupeerzaag	4351FCTJ	
Geleiderail 1400 mm	194368-5	
Extra cirkelzaagblad	B-32007	
Decoupeerzaagbladen	5	
Draagtas	B-57613	
Prijs in €	excl. btw	€ 609,00
	incl. btw	€ 736,89

INVALCIRKELZAAG

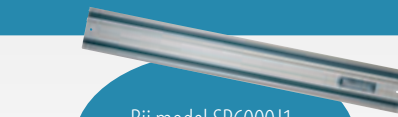

Bij model SP6000J1  
2 x geleiderail 1,4 m  
+ koppelstrips

	SP6000J	SP6000J1
Nominaal vermogen	1300 W	1300 W
Zaagdiepte (90°)	57 mm	57 mm
Zaagdiepte (45°)	40 mm	40 mm
Max. zaagdiepte (48°)	38 mm	38 mm
Ø Zaagblad	165 mm	165 mm
Gewicht	4,4 kg	4,4 kg
Prijs in €	excl. btw	€ 379,00
	incl. btw	€ 458,59

CIRKELZAGEN



5008MGJX



Zaagblad gratis bij 5008MGJX t.w.v. € 22,90



HS7101JX



2 x zaagblad 12 tanden bij HS7101JX t.w.v. € 37,20  
2 x zaagblad 16 tanden bij 5903RKX1 t.w.v. € 45,80



HS0600



5143R

	HS6601	HS6101J	HS7601J	HS7101JX	5008MGJX	5903RKX1	HS0600	5103R	5143R
Nominaal vermogen	1050 W	1100 W	1200 W	1400 W	1800 W	2000 W	2000 W	2100 W	2200 W
Zaagdiepte (90°)	54,5 mm	54,5 mm	66 mm	67 mm	75,5 mm	85 mm	101 mm	100 mm	130 mm
Ø Zaagblad	165 mm	165 mm	190 mm	190 mm	210 mm	235 mm	270 mm	270 mm	355 mm
Gewicht	3,7 kg	3,7 kg	4,0 kg	4,0 kg	5,1 kg	7,2 kg	6,9 kg	9,4 kg	14,0 kg
Prijs in €	excl. btw	€ 285,00	€ 285,00	€ 285,00	€ 285,00	€ 385,00	€ 355,00	€ 519,00	€ 849,00
	incl. btw	€ 187,55	€ 344,85	€ 211,75	€ 344,85	€ 344,85	€ 465,85	€ 429,55	€ 627,99

TAFEL-, AFKORT- EN VERSTEKZAGEN



LF1000



LF1000



LH1201FL

**SNELLE OMBOUW  
VAN TAFEL- NAAR  
AFKORTZAAGFUNCTIE**

	LH1040	LH1201	LF1000
<b>Verstekhoek</b>	<b>90°</b>	<b>45°</b>	<b>90°</b>
90°	91 x 95 mm 69 x 130 mm	95 x 155 mm 62 x 200 mm	68 x 155 mm 20 x 180 mm
45°	69 x 85 mm	62 x 125 mm	50 x 150 mm

	LH1040F	LH1201FL	LF1000
Nominaal vermogen	1650 W	1650 W	1650 W
Ø Zaagblad	260 mm	305 mm	260 mm
Gewicht	14,3 kg	20,7 kg	36 kg
Prijs in €	excl. btw	€ 649,00	€ 1.099,00
	incl. btw	€ 785,29	€ 1.329,79

AFKORT-VERSTEKZAAG



Kantelbaar naar links tot 45°

	LS1040N	
Nominaal vermogen	1650 W	
Ø Zaagblad	260 mm	
Max. zaagdiepte 0°	91 x 95 mm	
Max. zaagdiepte 45°	91 x 67 mm	
Gewicht	12,4 kg	
Prijs in €	excl. btw	€ 355,00
	incl. btw	€ 429,55

TAFELZAAG MET ONDERSTEL



	2704NX1	
Nominaal vermogen	1650 W	
Ø Zaagblad	260 mm	
Gewicht	34,9 kg	
Prijs in €	excl. btw	€ 1.399,00
	incl. btw	€ 1.692,79

TAFELZAAG



	MLT100N	
Nominaal vermogen	1500 W	
Ø Zaagblad	260 mm	
Gewicht	34,7 kg	
Prijs in €	excl. btw	€ 729,00
	incl. btw	€ 882,09



BOUWCIRKELZAAG



	2712	
Nominaal vermogen	2000 W	
Ø Zaagblad	315 mm	
Gewicht	52,9 kg	
Prijs in €	excl. btw	€ 499,00
	incl. btw	€ 603,79

TELESCOPISCHE AFKORT-VERSTEKZAGEN

PROMO

Gratis onderstel DEBWST06 t.w.v. € 259 bij LS1019L/LS1219L

Model	DEBWST06 - Onderstel
LS1019	✓ 
LS1219	✓ 

t.w.v. € 249,00 excl. btw

Max. lengte: 2550 mm

Nieuwe bevestigingsklemmen voor het bevestigen van verstekzagen op onderstellen DEBWST06 en DEAWST07



€ 78,90 excl. btw  
€ 95,50 incl. btw

JM00000219

# DXT

Deep and Exact Cutting Technology

De gepatenteerde constructie met drievoudige tandwieloverbrenging en uitsparing achter de flens laat toe om een groter deel van het zaagblad te benutten. Daardoor kunnen ook hoge plinten verticaal of in verstek afgekort worden.



LS1019L

LS1018L

Verstekhoek	LS1219L - Snijhoek		
	45° links	0°	45° rechts
0°	71x363 mm	107x363 mm	54x363 mm
45° L EN R	71x255 mm	107x255 mm	54x255 mm
60° L EN R	-	107x178 mm	-
PLINTEN	-	171 mm	-

Verstekhoek	LS1019L - Snijhoek		
	45° links	0°	45° rechts
0°	61x279 mm	91x279 mm	43x279 mm
45° L EN R	61x197 mm	91x197 mm	43x197 mm
60° L EN R	-	91x139 mm	-
PLINTEN	-	133 mm	-

Verstekhoek	LS0815FL - Snijhoek		
	45° links	0°	5° rechts
0°	50x305 mm	65x305 mm	60x305 mm
45° L EN R	50x215 mm	65x215 mm	-
60° R	-	65x150 mm	-

Verstekhoek	LS1018LN - Snijhoek		
	45° links	90°	45° rechts
0°	50x310 mm	91x310 mm	31x310 mm
45° L EN R	50x220 mm	91x220 mm	31x220 mm
60° R	-	91x153 mm	-

Verstekhoek	LS0714FLB - Snijhoek		
	45° links	90°	45° rechts
0°	40x300 mm	52x300 mm	40x300 mm
45° L EN R	40x212 mm	52x212 mm	-
57° R	-	52x163 mm	-

		LS0815FLN	LS1018LN	LS0714LN	LS1019L	LS1219L
Nominaal vermogen		1400 W	1430 W	1010 W	1510 W	1800 W
Ø zaagblad		216 mm	260 mm	190 mm	260 mm	305 mm
DXT		-	-	-	✓	✓
Gewicht		14,2 kg	19,9 kg	13,4 kg	26,3 kg	29,5 kg
Prijs in €	excl. btw	€ 369,00	€ 479,00	€ 579,00	€ 879,00	€ 999,00
	incl. btw	€ 446,49	€ 579,59	€ 700,59	€ 1.063,59	€ 1.208,79

ONDERSTEL AFKORT-VERSTEKZAGEN



Verbeterde bevestigingsklemmen!

- Ideaal voor het zagen van lange materialen
- Vernieuwde bevestigingsklemmen met een veilig en handig kliksysteem om moeiteloos verstekzagen te installeren en te demonteren.
- Gemakkelijk te transporteren

		DEAWST07
Afmetingen		1765 (l) x 750 (b) x 850 (h) mm
Max. lengte		3830 mm
Prijs in €	excl. btw	€ 299,00
	incl. btw	€ 361,79

HANDPALMVLAKSCHUURMACHINES



BO4565K



		BO4556K	BO4555K	BO4558	BO4565K
Nominaal vermogen		200 W	200 W	200 W	200 W
Afmetingen schuurvoet		112 x 102 mm	112 x 102 mm	112 x 102 mm	112 x 190 mm
Bevestiging		Klem	Velcro & klem	Klem	Velcro Driehoekspunt
Materiaal schuurvoet		Kunststof	Kunststof	Aluminium	Kunststof
Aantal schuurbewegingen		14000/min	14000/min	14000/min	14000/min
Schuuruitslag		1,5 mm	1,5 mm	1,5 mm	1,5 mm
Gewicht		1,1 kg	1,1 kg	1,2 kg	1,2 kg
Prijs in €	excl. btw	€ 99,00	€ 105,00	€ 109,00	€ 115,00
	incl. btw	€ 119,79	€ 127,05	€ 131,89	€ 139,15



VLAKSCHUURMACHINES MET VARIABELE SNELHEID



BO3711



		BO3711	BO4900VJ
Nominaal vermogen		190 W	330 W
Afmetingen schuurvoet		93 x 185 mm	115 x 232 mm
Aantal schuurbewegingen		4000-11000/min	4000-10000/min
Schuuruitslag		2,0 mm	2,6 mm
Gewicht		1,6 kg	2,7 kg
Prijs in €	excl. btw	€ 109,00	€ 275,00
	incl. btw	€ 131,89	€ 332,75

BANDSCHUURMACHINES



9403J:  
Zeer krachtig,  
ideaal voor intensief  
schuurwerk

9911J  
9403J



9403J



9911J



9032



		9911J	9924DB	9903J	9031	9032	9920J	9404J	9403J
Nominaal vermogen		650 W	850 W	1010 W	550 W	500 W	1010 W	1010 W	1200 W
Bandsnelheid		75-270 m/min	400 m/min	210-440 m/min	200-1000 m/min	300-1700 m/min	210-440 m/min	210-440 m/min	500 m/min
Schuurband		75 x 457 mm	75 x 610 mm	75 x 533 mm	30 x 533 mm	9 x 533 mm	75 x 610 mm	100 x 610 mm	100 x 610 mm
Gewicht		2,7 kg	4,8 kg	4,3 kg	2,1 kg	1,6 kg	4,5 kg	4,8 kg	5,7 kg
Prijs in €	excl. btw	€ 215,00	€ 295,00	€ 305,00	€ 315,00	€ 315,00	€ 335,00	€ 355,00	€ 385,00
	incl. btw	€ 260,15	€ 356,95	€ 369,05	€ 381,15	€ 381,15	€ 405,35	€ 429,55	€ 465,85



EXCENTRISCHE SCHUURMACHINES



BO5031K



BO5041K



BO6050J

	BO5031K	BO5041K	BO6030JX	BO6050J
Nominaal vermogen	300 W	300 W	310 W	750 W
Aantal schuurbewegingen	8000-24000/min	8000-24000/min	8000-20000/min	3200-13600/min
Schuuruitslag	2,8 mm	2,8 mm	3 mm	5,5 mm
Ø Schuurvoet	123 mm	123 mm	147 mm	147 mm
Gewicht	1,3 kg	1,4 kg	2,4 kg	2,6 kg
Prijs in €	excl. btw	€ 169,00	€ 189,00	€ 255,00
	incl. btw	€ 204,49	€ 228,69	€ 308,55

HAAKSE SCHUURMACHINE



SA7000C

		SA7000C
Nominaal vermogen		1600 W
Toerental onbelast		0-4000 t.p.m.
Ø schijf		180 mm
Gewicht		3,4 kg
Prijs in €	excl. btw	€ 245,00
	incl. btw	€ 296,45

EXCENTRISCHE POLIJSTMACHINE



PO6000C

		PO6000C
Nominaal vermogen		890 W
Aantal schuurbewegingen		0-13600 /min.
Ø schijf		150 mm
Schuuruitslag		5,5 mm
Gewicht		2,7 kg
Prijs in €	excl. btw	€ 329,00
	incl. btw	€ 398,09

SCHUUR- EN POETSMACHINE



9237CB

		9237CB
Nominaal vermogen		1200 W
Toerental		0-3200 t.p.m.
Ø schijf		180 mm
Gewicht		3,4 kg
Prijs in €	excl. btw	€ 319,00
	incl. btw	€ 385,99

BORSTELSCUURMACHINE



9741J

		9741J
Nominaal vermogen		860 W
Toerental		3500 t.p.m.
Gewicht		4,2 kg
Prijs in €	excl. btw	€ 539,00
	incl. btw	€ 652,19

GASNAGELPISTOOL VOOR  
AFWERKNAGELS 16 GA



**GF600SE**

Accu	7,2 V / 1,0 Ah	
Gemiddelde laadtijd	30 min	
Doorsnede nagel	1,6 mm	
Lengte nagel	15-64 mm	
Gewicht	2,2 kg	
Prijs in €	excl. btw	€ 579,00
	incl. btw	€ 700,59

GASNAGELPISTOOL  
VOOR BETON



**GN420CSE**

Accu	7,2 V / 1,0 Ah	
Gemiddelde laadtijd	30 min	
Doorsnede nagel	2,6-3,0 mm	
Lengte nagel	15-40 mm	
Gewicht	3,5 kg	
Prijs in €	excl. btw	€ 815,00
	incl. btw	€ 986,15

GASNAGELPISTOOL VOOR HOUT



**GN900SE**

Accu	7,2 V / 1,0 Ah	
Gemiddelde laadtijd	30 min	
Doorsnede nagel	2,9-3,3 mm	
Lengte nagel	50-90 mm	
Gewicht	3,3 kg	
Prijs in €	excl. btw	€ 609,00
	incl. btw	€ 736,89

PNEUMATISCH NIETPISTOOL 18 GA



**AT638A**

Werkdruk	4,2 - 8 bar	
Draadkaliber	18 Ga	
Doorsnede niet	1,1x1,3 mm	
Rugbreedte niet	5 mm	
Lengte niet	15-38 mm	
Gewicht	1,5 kg	
Prijs in €	excl. btw	€ 149,00
	incl. btw	€ 180,29

PNEUMATISCH ROLNAGELPISTOOL



**AN454**

Werkdruk	4,9-8,3 bar	
Doorsnede nagel	3,05 mm	
Lengte nagel	19-45 mm	
Gewicht	2,4 kg	
Prijs in €	excl. btw	€ 279,00
	incl. btw	€ 337,59

PNEUMATISCH CONSTRUCTIE-  
NAGELPISTOOL 21°



**AN924**

Werkdruk	4,9-8,3 bar	
Doorsnede nagel	3,76 mm	
Lengte nagel	50-90 mm	
Gewicht	3,8 kg	
Prijs in €	excl. btw	€ 325,00
	incl. btw	€ 393,25

MINIBRADPISTOOL 18 GA



**AF506**

Werkdruk	4,8-8,3 bar	
Draadkaliber	18 Ga	
Ø Nagelkop	2,0 mm	
Doorsnede nagel	1,2 mm	
Lengte nagel	15-50 mm	
Gewicht	1,4 kg	
Prijs in €	excl. btw	€ 125,00
	incl. btw	€ 151,25

BRADPISTOOL 16 GA



**AF601**

Werkdruk	0,49 - 8,3 bar	
Draadkaliber	16 Ga	
Doorsnede nagel	1,6 mm	
Lengte nagel	25 - 64 mm	
Gewicht	1,7 kg	
Prijs in €	excl. btw	€ 189,00
	incl. btw	€ 228,69

PNEUMATISCH  
CONSTRUCTIENAGELPISTOOL 34°



**AN943K**

Werkdruk	4,5-8,5 bar	
Ø Nagelkop	7,0 mm	
Doorsnede nagel	2,9-3,3 mm	
Lengte nagel	50-90 mm	
Gewicht	3,9 kg	
Prijs in €	excl. btw	€ 435,00
	incl. btw	€ 526,35

LASERAFSTANDSMETER



LD080PI



LD030P



	LD030P	LD050P	LD080PI
Bereik	30 m	50 m	80 m
Gewicht	0,1 kg	0,1 kg	0,1 kg
Prijs in €	excl. btw	€ 79,00	€ 105,00
	incl. btw	€ 95,59	€ 127,05

ROTERENDE LASER



PROMO  
gratis statief 2,7 m  
t.w.v. € 267,50



Inclusief ontvanger, bril voor laser, afstandsbediening en wandbevestiging

		SKR200Z
Rotatiesnelheid		0-600 t.p.m.
Bereik		100 m
Gewicht		1,6 kg
Prijs in €	excl. btw	€ 689,00
	incl. btw	€ 833,69

ACCU MUURSCANNER



De DWD181 gebruikt radartechnologie om nauwkeurig metaal, hout, elektrische bekabeling en andere objecten in wanden en vloeren te detecteren

4,1 inch kleurenscherm



		DWD181ZJ
Spanning		14,4V/18 V
Max. detectiediepte		25 - 180 mm
Tolerantie detectiediepte		± 5 mm
Minimum detecteerbare afstand tussen objecten		40 mm
Bijgeleverde lader/accu		-
Gewicht zonder accu		1,0 kg
Prijs in €	excl. btw	€ 1.239,00
	incl. btw	€ 1.499,19

KRUISLIJN- EN LIJNLASERS (CXT)

SK105DZ, SK105GDZ,  
SK106DZ & SK106GDZ  
**PROMO**  
Incl. BL1021B + DC105B



SK105DZ

SK106GDZ

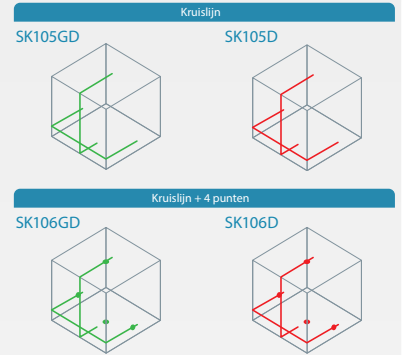

	SK105DZ	SK105GDZ	SK106DZ	SK106GDZ
Kleur	Rood	Groen	Rood	Groen
Projecties	1 H - 1 V	1 H - 1 V	1 H - 1 V + 4 punten	1 H - 1 V + 4 punten
Nauwkeurigheid	+3 mm / 10 m	+3 mm / 10 m	+3 mm / 10 m	+3 mm / 10 m
Bereik	25 m	25 m	25 m	25 m
Bijgeleverde accu's	1 x BL1021B + DC105B	1 x BL1021B + DC105B	1 x BL1021B + DC105B	1 x BL1021B + DC105B
Gewicht	0,67 kg	0,67 kg	0,69 kg	0,69 kg
Prijs in €	excl. btw	€ 209,00	€ 375,00	€ 329,00
	incl. btw	€ 252,89	€ 453,75	€ 398,09

**SK10GD/SK20GD/SK40GD**

- Groene laser met hoge helderheid
- Uiterst nauwkeurig
- Stevige constructie, beschermingsklasse IP54

Horizontaal / 4-Verticale lijnen      Horizontaal / 2-Verticale lijnen      Kruislijn + Punt

SK40GD

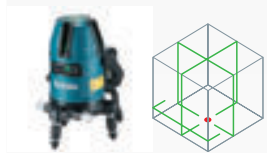

SK20GD

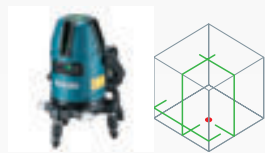

SK10GD

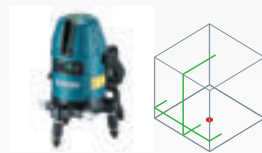

SK10GDZ, SK20GDZ, SK40GDZ  
SK209GDZ & SK312GDZ  
**PROMO**  
gratis powerpack 197658-5  
€ 159,00



SK209GDZ



SK312GDZ

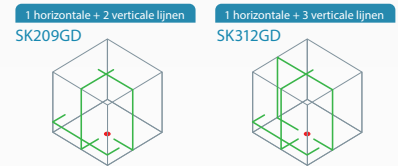

	SK10GDZ	SK20GDZ	SK40GDZ	SK209GDZ	SK312GDZ
Kleur	Groen	Groen	Groen	Groen	Groen
Projecties	1 H - 1 V + loodpunt	1 H - 2 V + loodpunt	1 H - 4 V + loodpunt	1 H - 2 V + loodpunt	1 H - 3 V + loodpunt
Nauwkeurigheid	±1 mm/10m	±1 mm/10m	±1 mm/10m	+1 mm / 10 m	+1 mm / 10 m
Bereik	-	-	-	-	-
Bijgeleverde accu's	2x BL1021B + DC105B	2x BL1021B + DC105B	2x BL1021B + DC105B	2x BL1021B + DC105B	2x BL1021B + DC105B
Gewicht	1,4 - 1,6 kg	1,4 - 1,6 kg	1,4 - 1,6 kg	1,5 - 1,6 kg	1,5 - 1,6 kg
Prijs in €	excl. btw	€ 489,00	€ 589,00	€ 805,00	€ 979,00
	incl. btw	€ 591,69	€ 712,69	€ 974,05	€ 1.184,59

KRUISLIJN- EN LIJNLASERS (CXT)

**SK700DZ/SK700GDZ:**

- 3x 360° laser (3 stralen: 1 horizontaal 360° + 2 verticaal 360°).
- Zeer hoge nauwkeurigheid.
- Blokkeerstand voor projectie van schuine lijnen en voor transport.
- Zeer grote autonomie dankzij de 12Vmax CXT batterij.
- IP54 bescherming.



**Hoge intensiteit**  
De SK700GDZ met krachtige groene laser biedt een uitstekende zichtbaarheid, ook in een omgeving met invallend daglicht.

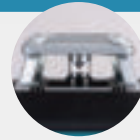

Via een sneldraaiende conische spiegel wordt de laserstraal over 360° geprojecteerd.

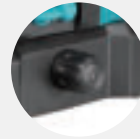

**Fijnafstelling:** Via een knop op de basis kan de unit zeer precies over een bereik van 10° gedraaid worden. De bevestiging is excentrisch zodat de kruising van de lijnen bij het draaien op hetzelfde punt blijft.

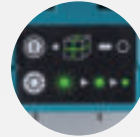

**Helderheidsinstelling**  
Via de 3 helderheidsinstellingen (100% - 75% - 50%) kan de intensiteit van de laser perfect aangepast worden aan de omstandigheden.



SK700DZ



SK700GDZ



SK700DZ & SK700GDZ  
**INCLUSIEF:**  
Powerpack 197658-5  
€ 159,00



**OPTIONEEL CP0000001**  
ADP09 Batterij adapter voor SK700  
Werkt met 8 x 1,5V AA-batterijen  
excl btw: € 29,30  
incl btw: € 35,50



	SK700DZ	SK700GDZ
Kleur	Rood	Groen
Projecties	3 x 360° rood	3 x 360° groen
Nauwkeurigheid	±2mm/10m	±2mm/10m
Bereik	25 m	35 m
Bijgeleverde accu's	2x BL1021B + DC105B	2x BL1021B + DC105B
Gewicht	0,99 - 1,2 kg	0,99 - 1,2 kg
Prijs in €	excl. btw	€ 479,00
	incl. btw	€ 579,59
Prijs in €	excl. btw	€ 609,00
	incl. btw	€ 736,89

**Accessories**

**TK0LM2000F**  
Statief 400 - 1140 mm  
excl btw: € 70,00  
incl btw: € 84,70



**TK0LM4001F**  
Statief 680 - 1800 mm  
excl btw: € 132,00  
incl btw: € 159,70



**TK0LM5030F**  
Statief 780 - 2900 mm  
excl btw: € 191,80  
incl btw: € 232,10



**LE00870137**  
Muur- en plafondbevestiging SK105, SK106, SK700  
excl btw: € 74,00  
incl btw: € 89,50



**TK00ET03F1**  
Muur- en plafondbevestiging SK10, SK20, SK40, SK209, SK312  
excl btw: € 235,00  
incl btw: € 284,35



**LE00855702**  
Laserlijnontvanger (80 m) SK105, SK106, SK700  
excl btw: € 226,10  
incl btw: € 273,60



**TK0LDG501G**  
Laserlijnontvanger SK10, SK20, SK40  
excl btw: € 189,00  
incl btw: € 228,69



**TK0LDG301G**  
Laserlijnontvanger SK209, SK312  
excl btw: € 286,50  
incl btw: € 346,70



**DECADP05**  
Adapter voor LXT batterijen  
excl btw: € 34,50  
incl btw: € 41,75



**199178-5**  
USB voedingskabel voor ADP05 (SK105 / SK106)  
excl btw: € 10,60  
incl btw: € 12,80



**199010-3**  
USB voedingskabel voor ADP05 (SK209 / SK312)  
excl btw: € 13,50  
incl btw: € 16,30





**DUC353Z DUC405Z**  
 € 351,24 excl. btw € 376,03 excl. btw  
 € 425,00 incl. btw € 455,00 incl. btw

**DUR368LZ**  
 € 313,22 excl. btw  
 € 379,00 incl. btw

**DUR190UT11**  
 € 362,81 excl. btw  
 € 439,00 incl. btw

**DUR369AZ**  
 € 412,40 excl. btw  
 € 499,00 incl. btw

**DUR368AZ**  
 € 354,55 excl. btw  
 € 429,00 incl. btw

**DLM481CT2**  
 € 784,30 excl. btw  
 € 949,00 incl. btw

**DLM539CT2**  
 € 825,62 excl. btw  
 € 999,00 incl. btw

**DLM536Z**  
 € 933,06 excl. btw  
 € 1.129,00 incl. btw

**DLM537Z**  
 € 1.313,22 excl. btw  
 € 1.589,00 incl. btw

**DLM463Z**  
 € 594,21 excl. btw  
 € 719,00 incl. btw

**DLM463PT2**  
 € 866,94 excl. btw  
 € 1.049,00 incl. btw

**DLM465Z**  
 € 904,96 excl. btw  
 € 1.095,00 incl. btw

**DLM465PT2**  
 € 1.156,20 excl. btw  
 € 1.399,00 incl. btw



1 accu 4,0 Ah na online registratie



**LM003GM102**  
 € 508,26 excl. btw  
 € 615,00 incl. btw

**LM004GM102**  
 € 528,10 excl. btw  
 € 639,00 incl. btw



1 accu 5,0 Ah gratis na online registratie  
 Bij aankoop van een LXT machine



Z-versies  
 geleverd zonder  
 batterijen of lader

Promo: gratis artikelen direct geleverd bij de machines



GRATIS  
 Gereedschapsset



DUC256Z001

**DUC256Z001**  
 € 400,83 excl. btw  
 € 485,00 incl. btw

**DUC356Z001**  
 € 409,09 excl. btw  
 € 495,00 incl. btw

**DUC406Z001**  
 € 412,40 excl. btw  
 € 499,00 incl. btw

**DUC306Z001**  
 € 404,13 excl. btw  
 € 489,00 incl. btw



GRATIS  
 Opbergtas



**UM600DSAEX**  
 € 202,48 excl. btw  
 € 245,00 incl. btw



**DUM604RFEX**  
 € 268,60 excl. btw  
 € 325,00 incl. btw

**DUM111SYX**  
 € 161,16 excl. btw  
 € 195,00 incl. btw

Gratis promo na online registratie



GRATIS  
 Blaas- en zuigmachine

**UC003GM101**  
 € 685,12 excl. btw  
 € 829,00 incl. btw

**UC004GM101**  
 € 690,08 excl. btw  
 € 835,00 incl. btw

**UC002GM101**  
 € 681,82 excl. btw  
 € 825,00 incl. btw

**UC010GT101**  
 € 855,37 excl. btw  
 € 1.035,00 incl. btw

**UC011GT101**  
 € 875,21 excl. btw  
 € 1.059,00 incl. btw

**UC012GT102**  
 € 880,17 excl. btw  
 € 1.065,00 incl. btw

**UC013GT102**  
 € 883,47 excl. btw  
 € 1.069,00 incl. btw



UC003GM101



UB001GM101

**UB001GM101**  
 € 544,63 excl. btw  
 € 659,00 incl. btw

UH007GM201

**UH004GM201**  
 € 891,74 excl. btw  
 € 1.079,00 incl. btw

**UH006GM201**  
 € 891,74 excl. btw  
 € 1.079,00 incl. btw

**UH013GM101**  
 € 962,81 excl. btw  
 € 1.165,00 incl. btw

**UH007GM201**  
 € 908,26 excl. btw  
 € 1.099,00 incl. btw

**UH005GM201**  
 € 908,26 excl. btw  
 € 1.099,00 incl. btw



DG001GM105

**DG001GM105**  
 € 891,74 excl. btw  
 € 1.079,00 incl. btw



GRATIS  
 Lantaarn met  
 radio en  
 Bluetooth



DUH501RTE

**DUH501RTE**  
 € 541,32 excl. btw  
 € 655,00 incl. btw



Deze XGT machines  
 zijn geleverd met  
 batterij(en) en lader

**Ontvang een gratis cadeau!**

Van 01 januari 2024 t.e.m. 31 maart 2024 kan u bij aankoop van de bovenstaande producten een gratis cadeau aanvragen! Voor de gratis producten na online registratie: surf naar [www.makita.be](http://www.makita.be) en vul het formulier in dat u kan terug vinden in 'Mijn Makita'. Na ontvangst van de correcte gegevens sturen we het gratis product zo snel mogelijk naar u toe.

De actie is uitsluitend van toepassing op aankopen bij een officieel erkende Makitaverdeler. Deze kan u terugvinden in de dealerlocator op [www.makita.be](http://www.makita.be). De complete voorwaarden van deze actie zijn na te lezen op de actiepagina in 'Mijn Makita'. Actie niet cumuleerbaar met andere acties en niet van toepassing op machines die deel uitmaken van een combokit of een omruiling in het kader van een reparatie.

### DUP362

ACCU SNOEISCHAAR 2 x 18 V



Bijgeleverde accu's	-	2 x accu 5,0 Ah	
Bijgeleverde lader	-	DC18RD	
Max. takdikte	33 mm	33 mm	
Gewicht	3,3 kg	3,3 kg	
Prijs in €	excl. btw	€ 1.230,58	€ 1.503,31
	incl. btw	€ 1.489,00	€ 1.819,00

### UP100D

SNOEISCHAAR 12VMAX



#### UP100DSMJ

Spanning	10,8 V	
Bijgeleverde accu's	1x BL1041B	
Bijgeleverde lader	DC10SB	
Maximaal afgegeven vermogen	170 W	
Snijcapaciteit	25 mm	
Afmetingen (L x B x H)	259 x 53 x 98 mm	
Gewicht	0,89 - 1,1 kg	
Prijs in €	excl. btw	€ 784,30
	incl. btw	€ 949,00



### UD2500

ELEKTRISCHE HAKSELAAR



#### UD2500

Nominaal vermogen	2500 W	
Max. toerental onbelast	40 t.p.m	
Max. takdikte	45 mm	
Geluidsdruk	84 dB(A)	
Gewicht	29,7 kg	
Prijs in €	excl. btw	€ 329,75
	incl. btw	€ 399,00



## DCU180Z

ACCU KRUIWAGEN 18 V



Elektronische snelheidsregeling



Demonteerbare achterwielen



Geïntegreerde ledverlichting



**PROMO**

GRATIS BUIZENFRAME  
(199009-8)

**18V**  
LITHIUM-ION

**XPT**  
EXTREME PROTECTIVE TECHNOLOGY

**BL**  
MOTOR

**LXT**



### Optionele accessoires

199008-0

Kipbak

€ 245,04 (excl. btw) / € 296,50 (incl. btw)



DCU180Z

Rijsnelheid	0 - 3,5 km/u	
Draagvermogen	130 kg	
Max. helling	12°	
Prijs in €	excl. btw	€ 1.023,97
	incl. btw	€ 1.239,00

## DCU603 / DCU604 / DCU605

ACCU KRUIWAGEN 2 X 18 V

**36V**

**WG**  
NET GUARD

**BL**  
MOTOR

**LXT**

- Roestvrije kunststof kuip.
- De binnenzijde en de voorkant zijn onder een hoek geplaatst om het uitkiepen te vergemakkelijken.



DCU603

Met kuip en manuele kiepfunctie

- Ideaal voor het transporteren van materiaal in dozen, kisten of zakken.
- Met een verstelbaar buizenframe.  
Lengte: 945 mm-1090 mm  
Breedte: 625 mm-1015 mm



DCU604

Met frame en manuele kiepfunctie

- Roestvrije kunststof kuip
- De kuip heeft een volledig vlakke bodem en afsluitbare afvoeropening onderaan.
- Ideaal voor het transport van vloeistoffen of korrelig materiaal.



DCU605

Met vaste, vlakke kuip

	DCU603Z	DCU604Z	DCU605Z
Spanning	2 x 18V	2 x 18V	2 x 18V
Type	Kantelbare kuip	Kantelbaar frame	Vaste kuip
Volume kuip	100 l	-	250 l
Max. lading vlak terrein	300 kg	300 kg	300 kg
Max. lading helling (3° - 12°)	180 kg	180 kg	180 kg
Rijsnelheid voorruit	1,5 - 3,5 - 5,0 km/h	1,5 - 3,5 - 5,0 km/h	1,5 - 3,5 - 5,0 km/h
Rijsnelheid achterruit	1,0 km/h	1,0 km/h	1,0 km/h
Gewicht	122 - 124 kg	122 - 124 kg	122 - 124 kg
Prijs in €	excl. btw	€ 4.949,59	€ 4.949,59
	incl. btw	€ 5.989,00	€ 5.989,00
		€ 4.767,77	€ 4.767,77
		€ 5.769,00	€ 5.769,00



### PF0800 / PF1100

DOMPELPOMPEN VOOR ZUIVER WATER



PF0800

PF1010

PF1100

PF1110

### PF1010 / PF1110

DOMPELPOMPEN VOOR VUIL WATER

		PF0800	PF1010	PF1100	PF1110
Nominiaal vermogen		800 W	1100 W	1100 W	1100 W
Max. debiet		220 l/min	240 l/min	250 l/min	250 l/min
Max. opvoerhoogte		9 m	10 m	9 m	10 m
Gewicht		6,1 kg	6,6 kg	6,7 kg	7,0 kg
Prijs in €	excl. btw	€ 98,35	€ 106,21	€ 131,40	€ 139,67
	incl. btw	€ 119,00	€ 129,00	€ 158,99	€ 169,00

### DUS108Z / DUS158Z

ACCU RUGSPROEIERS



DUS158Z



		DUS108Z	DUS158Z
Spanning		18V	18V
Bijgeleverde accu's		-	-
Tankinhoud		10l	15l
Debiet		0,8 - 1,3 l/min	0,8 - 1,3 l/min
Max. druk		3,0 bar	3,0 bar
Afmetingen		325 x 237 x 439 mm	325 x 237 x 517 mm
Gewicht		4,6 kg	4,6 kg
Prijs in €	excl. btw	€ 271,90	€ 296,69
	incl. btw	€ 329,00	€ 359,00



### PM001GZ01

ACCU RUGGEDRAGEN VERNEVELAAR



		PM001GZ01
Spanning		36V (40Vmax)
Tankinhoud		15,0 l
Luchtdebiet		9,0 - 11,0 - 13,3 m <sup>3</sup> /min
Blaaskracht		6,0 - 9,5 - 15 N
Verstuifcapaciteit		500 - 1400 ml/min
Geluidsdruk		87 dB(A)
Gewicht		13,2 - 15,7 kg
Prijs in €	excl. btw	€ 990,91
	incl. btw	€ 1.199,00

### US053DZ / DUS054Z

ACCU COMPACTE SPROEIER

UITSCHUIFBARE SPUITLANS: 0,5 - 0,7 M



		US053DZ	DUS054Z
Spanning		10,8V (12Vmax)	18V
Bijgeleverde accu's		-	-
Tankinhoud		5 l	5 l
Debiet		0,2 l/min	0,2 l/min
Max. druk		2,6 bar	2,6 bar
Afmetingen		340 x 183 x 360 mm	340 x 183 x 360 mm
Gewicht		2,9 - 3,0 kg	3,2 - 3,5 kg
Prijs in €	excl. btw	€ 185,95	€ 185,95
	incl. btw	€ 225,00	€ 225,00

DUS054Z

### HW001GZ

ACCU HOGEDRUKREINIGER  
40VMAX



HW001G



### HW001G

- Hoge reinigingskracht met goede balans tussen druk en debiet
- Voeding middels één of twee 40Vmax accu's
- 3 vermogensstanden
- Telescopisch handvat en compartiment voor de accessoires
- Autonomie bij max. vermogen: 18 min (2x BL4050F)

**NIEUW**

#### HW001GZ

Spanning	36V (40Vmax)	
Bijgeleverde accu's	-	
Lader	-	
Werkdruk	30/55/85 bar	
Debiet	3,0/4,2/5,5 l/min	
Lengte hogedrukslang	6 m	
Gewicht	10,1 - 13,2 kg	
Prijs in €	excl. btw	€ 718,18
	incl. btw	€ 869,00

### DHW080ZK

ACCU HOGEDRUKREINIGER

**18V + 18V → 36V**

Capaciteit  
watertank

**50 l**

Werkdruk

**30/55 bar**

Debiet

**4,0/5,5 l/min**

#### Compatibel

Er is een breed assortiment aan hulpstukken beschikbaar, ze zijn ook compatibel met de HW1200 / HW1300.



#### DHW080ZK

Spanning	2 x 18V	
Bijgeleverde accu's	-	
Lader	-	
Werkdruk	30/55 bar	
Debiet	4,0/5,5 l/min	
Inhoud watertank	50 l	
Gewicht	7,1-7,7 kg	
Prijs in €	excl. btw	€ 569,42
	incl. btw	€ 689,00

### HW1200 / HW1300 / HW131 / HW151

ELEKTRISCHE HOGEDRUKREINIGERS



HW1300



HW151



HW131

	HW1200	HW1300	HW131	HW151
Vermogen	1800 W	1800 W	2200 W	2500 W
Max. druk	120 bar	130 bar	130 bar	150 bar
Max. debiet	420 l/u	420 l/u	500 l/u	500 l/u
Haspel	10 m	10 m	15 m	10 m
Gewicht	11,0 kg	12,7 kg	33 kg	26,9 kg
Prijs in €	excl. btw	€ 304,96	€ 387,60	€ 486,78
	incl. btw	€ 369,00	€ 469,00	€ 589,00

**DDG460 / DDG461**  
ACCU GRONDBOOR 2 x 18 V



DDG460Z7

Met mechanische slipkoppeling en omkeerschakelaar

**NIEUW**

	DDG460Z7	DDG460T2X7	DDG461Z
Spanning	2 x 18 V	2 x 18 V	2 x 18 V
Max. boorcapaciteit	200 mm	200 mm	200 mm
Aansluiting	Boorkop en adapter	Boorkop en adapter	Directe as-gat verbinding
Max. koppel	136 Nm	136 Nm	136 Nm
Toerental onbelast	0 - 350 min <sup>-1</sup> 0 - 1400 min <sup>-1</sup>	0 - 350 min <sup>-1</sup> 0 - 1400 min <sup>-1</sup>	0 - 350 min <sup>-1</sup> 0 - 1400 min <sup>-1</sup>
Bijgeleverde accu's	-	2x BL1850B	-
Bijgeleverde lader	-	DC18RD	-
Gewicht	7,3 - 8,2 kg	7,3 - 8,2 kg	7,0 - 7,6 kg
Prijs in €	excl. btw	€ 627,27	€ 908,26
	incl. btw	€ 759,00	€ 1.099,00
		€ 544,63	€ 659,00

**DG001G / DG002G**  
ACCU GRONDBOOR 40VMAX



**NIEUW**

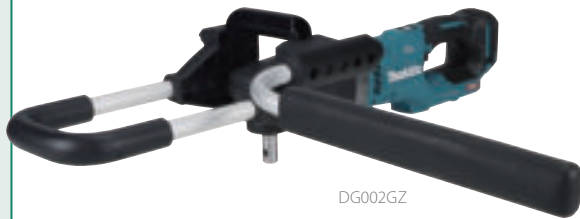

DG002GZ

Met mechanische slipkoppeling en omkeerschakelaar

**PROMO**

gratis AS001GZ na online registratie DG001GM105



	DG001GZ05	DG001GM105	DG002GZ
Spanning	36V (40Vmax)	36V (40Vmax)	36 V (40Vmax)
Max. boorcapaciteit	200 mm	200 mm	200 mm
Aansluiting	Boorkop en adapter	Boorkop en adapter	Directe as-gat verbinding
Max. koppel	136 Nm	136 Nm	136 Nm
Toerental onbelast	0 - 400 min <sup>-1</sup> 0 - 1 500 min <sup>-1</sup>	0 - 400 min <sup>-1</sup> 0 - 1 500 min <sup>-1</sup>	0 - 400 min <sup>-1</sup> 0 - 1 500 min <sup>-1</sup>
Bijgeleverde accu's	-	1 x BL4040	-
Bijgeleverde lader	-	DC40RA	-
Gewicht	7,2 - 8,1 kg	7,2 - 8,1 kg	6,8 - 8,0 kg
Prijs in €	excl. btw	€ 627,27	€ 891,74
	incl. btw	€ 759,00	€ 1.079,00
		€ 544,63	€ 659,00

**Adapters**



**327687-6**  
Adapter Type D voor Makita grondboren  
€ 36,60 excl. btw  
€ 44,29 incl. btw



**327684-2**  
Adapter Type A voor Stihl grondboren  
€ 44,00 excl. btw  
€ 53,24 incl. btw

**Grondboren met hexagonale schacht**



Artikel nr.	Diameter	Totale lengte	Nuttige lente	Prijs (excl. btw)	Prijs (incl. btw)
D-75415	Ø 30 mm	600 mm	200 mm	€ 22,48	€ 27,20
D-75421	Ø 45 mm	600 mm	200 mm	€ 24,46	€ 29,60
D-75437	Ø 70 mm	600 mm	200 mm	€ 32,56	€ 39,40
D-75443	Ø 100 mm	600 mm	200 mm	€ 36,69	€ 44,40
D-75459	Ø 130 mm	600 mm	200 mm	€ 40,83	€ 49,40
E-17049	Ø 40 mm	600 mm	470 mm	€ 109,50	€ 132,50

E-17049 met dubbele schroef en langere werklengte!

**Grondboren te gebruiken met adapter (type D) incl. borgpen**

Artikel nr.	Diameter	Totale lengte	Nuttige lengte	Prijs (excl. btw)	Prijs (incl. btw)
E-13611	Ø 50 mm	800 mm	550 mm	€ 122,40	€ 148,10
E-13627	Ø 60 mm	800 mm	550 mm	€ 127,52	€ 154,30
E-13633	Ø 80 mm	800 mm	550 mm	€ 132,56	€ 160,40
E-07294	Ø 100 mm	800 mm	550 mm	€ 138,02	€ 167,00
E-07303	Ø 150 mm	800 mm	550 mm	€ 148,51	€ 179,70
E-07319	Ø 200 mm	800 mm	550 mm	€ 158,93	€ 192,30

Vervangmesjes	Prijs (excl. btw)	Prijs (incl. btw)
E-13649	€ 16,78	€ 20,30
E-13655	€ 17,27	€ 20,90
E-13661	€ 17,69	€ 21,40
E-07630	€ 17,69	€ 21,40
E-07646	€ 18,93	€ 22,90
E-07652	€ 20,41	€ 24,70

**E-07325**  
Verlengstuk  
540 mm

€ 51,20 excl. btw  
€ 61,95 incl. btw



**E-07331**  
Borgpen

€ 5,20 excl. btw  
€ 6,29 incl. btw





## DUX18

ACCU COMBISYSTEEM 18 V



DUX18Z

		DUX18Z	DUX18ZX1
Platform		LXT 18 V	LXT 18 V
Max. afgegeven vermogen		470 W	470 W
Toerental onbelast		0 - 6800 / 0 - 9700 min <sup>-1</sup>	0 - 6800 / 0 - 9700 min <sup>-1</sup>
Bijgeleverde accessoires		-	EM408MP
Bijgeleverde accu's / laders		-	-
Prijs in €	excl. btw	€ 205,79	€ 271,90
	incl. btw	€ 249,00	€ 329,00

## DUX60

ACCU COMBISYSTEEM  
2 x 18 V



DUX60Z

	DUX60Z	DUX60ZN1	DUX60ZM4	DUX60ZX8
Platform	LXT 2 x 18 V	LXT 2 x 18 V	LXT 2 x 18 V	LXT 2 x 18 V
Max. afgegeven vermogen	600 W	600 W	600 W	600 W
Toerental onbelast	0 - 5700 / 0 - 8200 / 0 - 9700 min <sup>-1</sup>	0 - 5700 / 0 - 8200 / 0 - 9700 min <sup>-1</sup>	0 - 5700 / 0 - 8200 / 0 - 9700 min <sup>-1</sup>	0 - 5700 / 0 - 8200 / 0 - 9700 min <sup>-1</sup>
Bijgeleverde accessoires	-	EN401MP	EM404MP	EN401MP EM404MP
Bijgeleverde accu's / laders	-	-	-	-
Prijs in €	excl. btw	€ 280,17	€ 466,94	€ 395,87
	incl. btw	€ 339,00	€ 565,00	€ 479,00

## UX01GZ

ACCU COMBISYSTEEM 40VMAX



		UX01GZ	UX01GZ01
Platform		XGT 40Vmax	XGT 40Vmax
Max. afgegeven vermogen		1000 W	1000 W
Toerental onbelast		0 - 5700 / 0 - 8200 / 0 - 9700 min <sup>-1</sup>	0 - 5700 / 0 - 8200 / 0 - 9700 min <sup>-1</sup>
Bijgeleverde accessoires		-	EM404MP
Bijgeleverde accu's / laders		-	-
Prijs in €	excl. btw	€ 280,17	€ 395,87
	incl. btw	€ 339,00	€ 479,00

## COMBISYSTEEM OPZETSTUKKEN

Artikel	Referentie	Ø (mm)	Prijs excl. btw	Prijs incl. btw
BOSMAAIER (Voor DUX18 enkel EM408MP geschikt)				
EM404MP	198768-1	450 mm	€ 120,00	€ 145,20
EM401MP	195888-2	300 mm	€ 105,00	€ 127,05
EM400MP	195648-2	420 mm	€ 94,50	€ 114,35
EM406MP	198779-6	420 mm	€ 99,00	€ 119,79
EM408MP	191N31-5	300 mm	€ 99,00	€ 119,79
ROTORSCHAAR				
EM407MP	191M56-3		€ 396,30	€ 479,52
GRASTRIMMER				
ER400MP	195522-4	410 mm	€ 87,60	€ 106,00
SNOEKETINGZAAG				
EY403MP	191T38-7		€ 264,20	€ 319,68
STOKHEGGENSCHAAR				
EN401MP	196256-2		€ 245,70	€ 297,30
EN410MP	197726-4		€ 198,70	€ 240,43
GRONDFREES				
KR400MP	199181-6		€ 249,00	€ 301,29
BOORDENSNIJDER				
EE400MP	196752-0		€ 123,10	€ 148,95
VERLENGSTUK				
LE400MP	191E24-8		€ 87,60	€ 106,00
ROLVEGER				
SW400MP	199339-7		€ 359,00	€ 434,39
ROLBORSTEL				
BR400MP	199318-5		€ 349,00	€ 422,29
BLAZER				
UB401MP	191P72-3		€ 143,50	€ 173,64
UB402MP	1912R8-4		€ 92,50	€ 111,93
WATERPOMP				
PF400MP	DEAPF400MP		€ 199,00	€ 240,79
MAAIBALK				
<b>NIEUW</b>	EN424MP	1913C9-3	€ 227,50	€ 275,28



### DUR193

ACCU GRASTRIMMER 18V



DUR193RF

	DUR193Z	DUR193RF
Spanning	18 V	18 V
Bijgeleverde accu's	-	1 x accu 3,0 Ah
Bijgeleverde lader	-	DC18RC
Snelheden	1	1
BL motor	-	-
ADT	-	-
AFT	-	-
Handgreep	Rond ("D")	Rond ("D")
Schacht	Telescopisch	Telescopisch
Max. uitgangsvermogen	280 W	280 W
Gewicht	2,3 - 2,6 kg	2,3 - 2,6 kg
Prijs in €	excl. btw	€ 106,61
	incl. btw	€ 129,00

### DUR189

ACCU GRASTRIMMER 18V



DUR189RFE

	DUR189Z	DUR189RFE
Bijgeleverde accu's	-	2x accu 3,0 Ah
Bijgeleverde lader	-	DC18RC
Snelheden	3	3
ADT	✓	✓
AFT	-	-
Handgreepvorm	D	D
Max. uitgangsvermogen	240 W	240 W
Gewicht	3,0 - 3,3 kg	3,0 - 3,3 kg
Prijs in €	excl. btw	€ 210,74
	incl. btw	€ 255,00

### DUR194

ACCU GRASTRIMMER 18V



- COMPATIBEL MET DRAADKOP, KOP MET NYLON MESSEN EN METALEN 8-TANDS MAAIBLAD
- MET UNIVERSELE BESCHERMKAP



DUR194SFX2

	DUR194ZX3	DUR194SFX2	DUR194RTX1
Spanning	18 V	18 V	18 V
Bijgeleverde accu's	-	1x accu 3,0 Ah	1x accu 5,0 Ah
Bijgeleverde lader	-	DC18SD	DC18RC
Snelheden	2	2	2
BL motor	-	-	-
ADT	-	-	-
AFT	-	-	-
Handgreep	D	D	D
Max. uitgangsvermogen	230 W	230 W	230 W
Gewicht	2,6 - 2,9 kg	2,6 - 2,9 kg	2,6 - 2,9 kg
Prijs in €	excl. btw	€ 156,20	€ 260,33
	incl. btw	€ 189,00	€ 315,00

### DUR190 / DUR191

ACCU GRASTRIMMERS 18V

#### PROMO

Gratis BL 1850B bij DUR190UT11 na online registratie



SCHACHT IN EÉN DEEL (DUR190)

DEMONTEERBARE SCHACHT VOOR TRANSPORT (DUR191)



DUR190UT11

DUR191LZX9

- DUR190UT11 INCLUSIEF MAAIMES
- EASY FILL MAAIKOP OP DUR190UZ9, DUR190UT11 EN DUR191LZX9

	DUR190UZ9	DUR190UT11	DUR191LZX3	DUR191LZX9
Spanning	18V	18V	18V	18V
Bijgeleverde accu's	-	1 x accu 5,0 Ah	-	-
Lader	-	DC18SD	-	-
Snelheden	3	3	3	3
ADT	-	✓	✓	✓
AFT	-	✓	✓	✓
Handgreepvorm	U	U	D	D
Max. uitgangsvermogen	240 W	240 W	240 W	240 W
Gewicht	3,4 kg	3,1 kg	3,1 kg	3,1 kg
Prijs in €	excl. btw	€ 230,58	€ 362,81	€ 252,07
	incl. btw	€ 279,00	€ 439,00	€ 305,00

**UR016G / UR017G**

ACCU BOSMAAIERS 40VMAX



UR016GZ

	UR016GZ	UR017GZ	
Spanning	36V (40Vmax)	36V (40Vmax)	
Bijgeleverde accu's	-	-	
Bijgeleverde lader	-	-	
Toerental onbelast	3500/5300/ 6500 min <sup>-1</sup>	3500/5300/ 6500 min <sup>-1</sup>	
Handgreepvorm	Dubbel ("U")	Rond ("D")	
ADT	✓	✓	
AFT	✓	✓	
Max. uitgangsvermogen	600 W	600 W	
Gewicht	4,6 - 5,4 kg	4,2 - 4,8 kg	
Prijs in €	excl. btw	€ 362,81	€ 346,28
	incl. btw	€ 439,00	€ 419,00

**UR002G / UR006G / UR007G**

ACCU BOSMAAIERS 40VMAX

**PROMO**

Gratis AS001GZ na online registratie UR006GM101



UR002GZ01

UR006GM101



	UR002GZ01	UR006GZ02	UR007GZ01	
Spanning	36V (40Vmax)	36V (40Vmax)	36V (40Vmax)	
Max. toerental onbelast	3500 - 5300 - 6500 min <sup>-1</sup>	4600 - 5500 - 7000 min <sup>-1</sup>	4600 - 5500 - 7000 min <sup>-1</sup>	
Snelheden	3 + auto	3 + auto	3 + auto	
Handgreepvorm	Dubbel ("U")	Dubbel ("U")	Rond ("D")	
ADT	✓	✓	✓	
AFT	✓	✓	✓	
Bijgeleverde accu's	0	0	0	
Bijgeleverde lader	0	0	0	
Max. uitgangsvermogen	550 W	1 kW	1 kW	
Gewicht	4,6 - 5,3 kg	5,7 - 6,3 kg	5,7 - 6,3 kg	
Prijs in €	excl. btw	€ 395,87	€ 420,66	€ 437,19
	incl. btw	€ 479,00	€ 509,00	€ 529,00

**DUR368 / DUR369**

ACCU BOSMAAIERS 2X18V



**PROMO**

Gratis BL1850B na online registratie



DUR369AZ

DUR368LZ

	DUR368LZ	DUR368AZ	DUR369AZ	
Spanning	2x 18V	2x 18V	2x 18V	
Max. toerental onbelast	6500 t.p.m.	6500 t.p.m.	7000 t.p.m.	
Bijgeleverde accu's	-	-	-	
Bijgeleverde lader	-	-	-	
Snelheden	3	3	3	
ADT	✓	✓	✓	
AFT	✓	✓	✓	
Handgreep	Rond ("D")	Dubbel ("U")	Dubbel ("U")	
Max. uitgangsvermogen	550 W	550 W	1000 W	
Gewicht	3,9 - 4,5 kg	4,1 - 4,7 kg	5,9 - 6,5 kg	
Prijs in €	excl. btw	€ 313,22	€ 354,55	€ 412,40
	incl. btw	€ 379,00	€ 429,00	€ 499,00



**UR013G / UR014G**  
ACCUBOSMAAIERS 40VMAX



UR013GZ04

**UR013G/UR014G**

Extra hoog koppel in "High torque mode", bijzonder geschikt voor zware toepassingen

**UR014G**

- enkel te gebruiken met draadkop  
- de draairichting is omkeerbaar



UR014GZ

		UR013GZ04	UR014GZ
Spanning		36V (40Vmax)	36V (40Vmax)
Toerental onbelast		3500 - 6700 min <sup>-1</sup>	4000 - 5000 min <sup>-1</sup>
Bijgeleverde accu's		-	-
Bijgeleverde lader		-	-
Handgreepvorm		Dubbel ("U")	Rond ("D")
ADT		-	-
AFT		✓	✓
Max. uitgangsvermogen		1500 W	1500 W
Gewicht		5,9 - 7,2 kg	5,5 - 6,7 kg
Prijs in €	excl. btw	€ 528,10	€ 511,57
	incl. btw	€ 639,00	€ 619,00

■ **Optionele accessoires**



**Hakselmes 270 mm**  
199874-5  
€ 35,12 (excl. btw)  
€ 42,50 (incl. btw)

**Beschermkap voor hakselmes**  
199875-3  
€ 23,47 (excl. btw)  
€ 28,40 (incl. btw)



**Zaagblad met beitelstanden 225 mm**  
199872-9  
€ 32,81 (excl. btw)  
€ 39,70 (incl. btw)

**Beschermkap voor zaagblad UR012G**  
199873-7  
€ 25,54 (excl. btw)  
€ 30,90 (incl. btw)



**Heupharnas**  
191E43-4  
enkel te gebruiken met PDC01 en PDC1200  
€ 14,13 (excl. btw)  
€ 17,10 (incl. btw)

**UR012G**  
ACCUBOSMAAIER 2 x 40VMAX



UR012GZ02

Max. uitgangsvermogen  
**2,0 kW**

		UR012GZ02
Spanning		2 x 40Vmax
Max. toeren onbelast		3500 - 5000 - 6800 min <sup>-1</sup>
Snelheden		3 + auto
ADT		✓
AFT		✓
Bijgeleverde accu's		-
Bijgeleverde lader		-
Max. uitgangsvermogen		2,0 kW
Gewicht		8,0 - 9,3 kg
Prijs in €	excl. btw	€ 742,98
	incl. btw	€ 899,01

## UC100D / DUC101

ACCU SNOEIZAGEN



DUC101SF

	UC100DZ	DUC101Z	DUC101SF
Spanning	10,8V (12Vmax)	18V	18V
Bijgeleverde accu's	-	-	1x accu 3,0 Ah
Bijgeleverde lader	-	-	DC18SD
BL motor	✓	✓	✓
Snelspansysteem	✓	✓	✓
Zwaardlengte	100 mm	100 mm	100 mm
Ketting	80 TXL (0,325, 1,1 mm)	80 TXL (0,325, 1,1 mm)	80 TXL (0,325, 1,1 mm)
Kettingsnelheid	8 m/s	8 m/s	8 m/s
Gewicht	1,5-1,6 kg	1,6-2,0 kg	1,6-2,0 kg
Prijs in €	excl. btw	€ 152,89	€ 189,26
	incl. btw	€ 185,00	€ 229,00
		€ 304,96	€ 369,00

## DUA301

ACCU HOOGSNOEIER 2 x 18 V

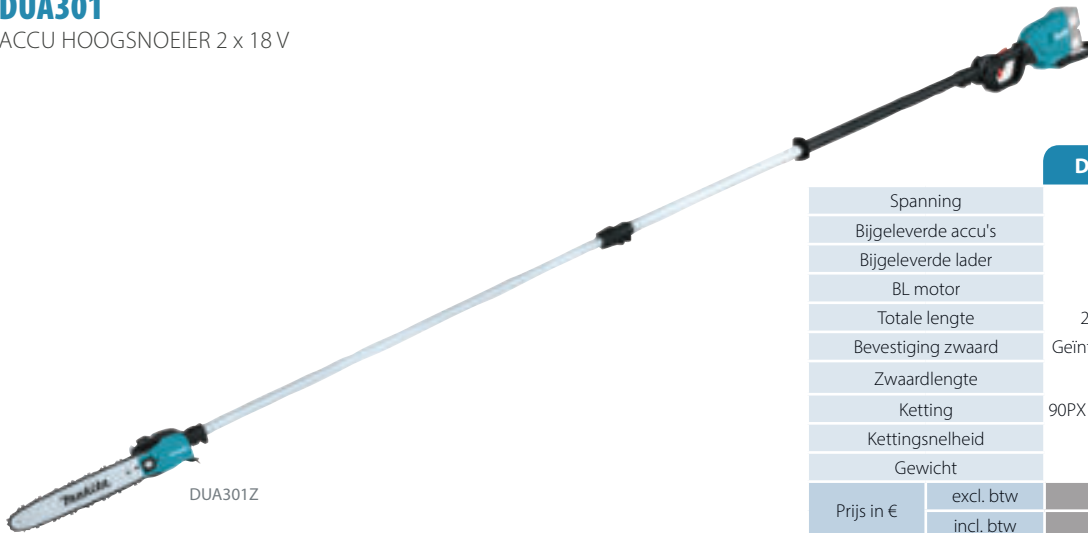

DUA301Z

	DUA301Z	DUA301PT2
Spanning	2x 18V	2x 18V
Bijgeleverde accu's	0	2x 5,0 Ah
Bijgeleverde lader	-	DC18RD
BL motor	✓	✓
Totale lengte	2,53 - 3,76 m	2,53 - 3,76 m
Bevestiging zwaard	Geïntegreerde moer	Geïntegreerde moer
Zwaardlengte	30 cm	30 cm
Ketting	90PX (0,325", 1,1 mm)	90PX (0,325", 1,1 mm)
Kettingsnelheid	0 - 20 m/s	0 - 20 m/s
Gewicht	7,8 - 8,5 kg	7,8 - 8,5 kg
Prijs in €	excl. btw	€ 602,48
	incl. btw	€ 729,00
		€ 858,68
		€ 1.039,00

## UA004G

ACCU HOOGSNOEIER 40VMAX



UA004GZ

	UA004GZ	UA004GM101
Spanning	36V (40Vmax)	36V (40Vmax)
Bijgeleverde accu's	-	1x 4,0 Ah
Bijgeleverde Lader	-	DC40RA
BL motor	✓	✓
Totale lengte	2,53 - 3,76 m	2,53 - 3,76 m
Bevestiging zwaard	Geïntegreerde moer	Geïntegreerde moer
Zwaardlengte	30 cm	30 cm
Ketting	90PX (0,325", 1,1 mm)	90PX (0,325", 1,1 mm)
Kettingsnelheid	0 - 20 m/s	0 - 20 m/s
Gewicht	7,8 - 9,1 kg	7,8 - 9,1 kg
Prijs in €	excl. btw	€ 602,48
	incl. btw	€ 729,00
		€ 866,94
		€ 1.049,00



### DUC122 / DUC254

ACCU SNOEIKETTINGZAGEN 18 V



OPGELET: voor het gebruik van een tophandle kettingzaag is een opleiding vereist. Raadpleeg steeds de veiligheidsvoorschriften.

		DUC122ZK	DUC122RTE	DUC254Z001
Spanning		18V	18V	18V
Bijgeleverde accu's		-	1 x accu 5,0 Ah	-
Bijgeleverde lader		-	DC18RC	-
BL motor		-	-	✓
Spansysteem		Snelspansysteem	Snelspansysteem	Geïntegreerde moeren
Zwaardlengte		11,5 cm	11,5 cm	25 cm
Ketting		025 (1/4", 1,3 mm)	025 (1/4", 1,3 mm)	80PX (0,325", 1,1 mm)
Kettingsnelheid		5 m/s	5 m/s	24 m/s
Gewicht		2,6 kg	2,6 kg	2,8 - 3,2 kg
Prijs in €	excl. btw	€ 202,48	€ 409,09	€ 271,90
	incl. btw	€ 245,00	€ 495,00	€ 329,00

### DUC256 / -306 / -356 / -406

ACCU SNOEIKETTINGZAGEN 2 x 18 V

### PROMO

gratis 87-delige gereedschapset E-08458



**XPT**  
DUC256  
DUC306  
DUC356  
DUC406



		DUC256Z001	DUC306Z001	DUC356Z001	DUC406Z001
Spanning		2x 18V	2x 18V	2x 18V	2x 18V
Bijgeleverde accu's		-	-	-	-
Bijgeleverde lader		-	-	-	-
BL motor		✓	✓	✓	✓
Snelspansysteem		-	-	-	-
Geïntegreerde moeren		✓	✓	✓	✓
Zwaardlengte		25 cm	30 cm	35 cm	40 cm
Ketting		80 TXL (0,325, 1,1 mm)	80 TXL (0,325, 1,1 mm)	80 TXL (0,325, 1,1 mm)	80 TXL (0,325, 1,1 mm)
Kettingsnelheid		20 m/s	20 m/s	20 m/s	20 m/s
Gewicht		4,6-5,1 kg	4,6-5,1 kg	4,6-5,1 kg	4,6-5,1 kg
Prijs in €	excl. btw	€ 400,83	€ 404,13	€ 409,09	€ 412,40
	incl. btw	€ 485,00	€ 489,00	€ 495,00	€ 499,00

### UC002G / UC003G / UC004G / UC006G

ACCU SNOEIKETTINGZAGEN 40VMAX

### PROMO

Gratis AS001GZ na online registratie UC002GM101, UC003GM101, UC004GM101



		UC002GZ	UC002GM101	UC003GZ	UC003GM101	UC004GZ	UC004GM101	UC006GZ
Spanning		36V (40Vmax)	36V (40Vmax)	36V (40Vmax)	36V (40Vmax)	36V (40Vmax)	36V (40Vmax)	36V (40Vmax)
Bijgeleverde accu's		-	1x 4,0 Ah	-	1x 4,0 Ah	-	1x 4,0 Ah	-
Bijgeleverde lader		-	DC40RA	-	DC40RA	-	DC40RA	-
BL motor		✓	✓	✓	✓	✓	✓	✓
Geïntegreerde moeren		✓	✓	✓	✓	✓	✓	✓
Zwaardlengte		25 cm	25 cm	30 cm	30 cm	35 cm	35 cm	25 cm Carving
Ketting		90PX (3/8" 1,1 mm)	90PX (3/8" 1,1 mm)	90PX (3/8" 1,1 mm)	90PX (3/8" 1,1 mm)	90PX (3/8" 1,1 mm)	90PX (3/8" 1,1 mm)	90PX (1/4", 1,3 mm)
Kettingsnelheid		0 - 24,8 m/s	0 - 24,8 m/s	0 - 24,8 m/s	0 - 24,8 m/s	0 - 24,8 m/s	0 - 24,8 m/s	0 - 24,8 m/s
Gewicht		3,8 - 4,7 kg	3,8 - 4,7 kg	3,8 - 4,7 kg	3,8 - 4,7 kg	3,8 - 4,7 kg	3,8 - 4,7 kg	3,8 - 4,7 kg
Prijs in €	excl. btw	€ 400,83	€ 681,82	€ 404,13	€ 685,12	€ 409,09	€ 690,08	€ 428,93
	incl. btw	€ 485,00	€ 825,00	€ 489,00	€ 829,00	€ 495,00	€ 835,00	€ 519,01

### DUC307 / DUC357

ACCU KETTINGZAGEN 18V



DUC357RTX2



	DUC307ZX2	DUC307RTX2	DUC357ZX2	DUC357RTX2	
Spanning	18V	18V	18V	18V	
Bijgeleverde accu's	-	1x 5,0 Ah	-	1x 5,0 Ah	
Bijgeleverde lader	-	DC18RC	-	DC18RC	
BL motor	✓	✓	✓	✓	
Snelspansysteem	✓	✓	✓	✓	
Zwaardlengte	30 cm	30 cm	35 cm	35 cm	
Ketting	90PX (3/8", 1,1 mm)	90PX (3/8", 1,1 mm)	90PX (3/8", 1,1 mm)	90PX (3/8", 1,1 mm)	
Kettingsnelheid	7,7 m/s	7,7 m/s	7,7 m/s	7,7 m/s	
Gewicht	4,2 - 4,4 kg	4,2 - 4,4 kg	4,2 - 4,4 kg	4,2 - 4,4 kg	
Prijs in €	excl. btw	€ 247,11	€ 346,28	€ 252,07	€ 351,24
	incl. btw	€ 299,00	€ 419,00	€ 305,00	€ 425,00

### DUC353 / DUC405

ACCU KETTINGZAGEN 2 x 18V



DUC405Z

**PROMO**

GRATIS ACCU 5,0 Ah na online registratie



	DUC353Z	DUC405Z	
Spanning	2x 18V	2x 18V	
Bijgeleverde accu's	-	-	
Bijgeleverde lader	-	-	
BL motor	✓	✓	
Zwaardlengte	35 cm	40 cm	
Bevestiging zwaard	Snelspansysteem	Geïntegreerde moeren	
Ketting	90PX (3/8", 1,1 mm)	90PX (3/8", 1,1 mm)	
Kettingsnelheid	20 m/s	20 m/s	
Gewicht	4,6 - 5,5 kg	4,6 - 5,5 kg	
Prijs in €	excl. btw	€ 351,24	€ 376,03
	incl. btw	€ 425,00	€ 455,00

### UC010G / UC011G / UC012G / UC013G

ACCU KETTINGZAAG 40Vmax



UC012GT102

UC013GT102

HOOG VERMOGEN  
HOGE KETTINGSNELHEID  
REGELEBAAR OLIEDEBIET  
LAAG TRILLINGSNIVEAU

**PROMO**

gratis AS001GZ na online registratie UC010GT101, UC011GT101, UC012GT102 & UC013GT102



	UC010GZ	UC010GT101	UC011GZ	UC011GT101	UC012GZ01	UC012GT102	UC013GZ01	UC013GT102	
Spanning	36V (40Vmax)	36V (40Vmax)	36V (40Vmax)	36V (40Vmax)	36V (40Vmax)	36V (40Vmax)	36V (40Vmax)	36V (40Vmax)	
Bijgeleverde accu's	-	1 x 5,0 Ah	-	1 x 5,0 Ah	-	1 x 5,0 Ah	-	1 x 5,0 Ah	
Bijgeleverde lader	-	DC40RA	-	DC40RA	-	DC40RA	-	DC40RA	
BL motor	✓	✓	✓	✓	✓	✓	✓	✓	
Geïntegreerde moeren	✓	✓	✓	✓	✓	✓	✓	✓	
Zwaardlengte	30 cm	30 cm	35 cm	35 cm	40 cm	40 cm	45 cm	45 cm	
Ketting	80TXL (0,325, 1,1 mm)	80TXL (0,325, 1,1 mm)	80TXL (0,325, 1,1 mm)	80TXL (0,325, 1,1 mm)	3/8" 1,3 mm	3/8" 1,3 mm	3/8" 1,3 mm	3/8" 1,3 mm	
Kettingsnelheid	0 - 25,5 m/s	0 - 25,5 m/s	0 - 25,5 m/s	0 - 25,5 m/s	0 - 25,5 m/s	0 - 25,5 m/s	0 - 25,5 m/s	0 - 25,5 m/s	
Gewicht	6,1 - 7,4 kg	6,1 - 7,4 kg	6,1 - 7,4 kg	6,1 - 7,4 kg	6,1 - 7,4 kg	6,1 - 7,4 kg	6,1 - 7,4 kg	6,1 - 7,4 kg	
Prijs in €	excl. btw	€ 561,16	€ 855,37	€ 566,12	€ 875,21	€ 569,42	€ 880,17	€ 574,38	€ 883,47
	incl. btw	€ 679,00	€ 1.035,00	€ 685,00	€ 1.059,00	€ 689,00	€ 1.065,00	€ 695,00	€ 1.069,00

## UM600D / DUM111 / DUM604

ACCU GRAS- EN HEGGENSCHAAR

### PROMO

Gratis opbergtas bij UM600DSAEX, DUM111SYX en DUM604RFEX



DUM604RFEX



DUM111SYX



	UM600DSAEX	DUM111SYX	DUM604RFEX	DUM604ZX	
Spanning	10,8 V (12Vmax)	18 V	18 V	18 V	
Bijgeleverde accu's	2 x accu 2,0 Ah	1 x accu 1,5 Ah	2 x accu 3,0 Ah	-	
Lader	DC10SB	DC18SD	DC18RC	-	
Snijlengte heggenschaar	20 cm	20 cm	20 cm	20 cm	
Snijbreedte grasschaar	16 cm	11 cm	16 cm	16 cm	
Maximale takdikte	8 mm				
Geleverd met	Grasschaar + Heggenschaar	Grasschaar + Heggenschaar	Grasschaar + Heggenschaar	Grasschaar + Heggenschaar	
Gewicht	1,2 kg	1,8 kg	1,8 kg	1,8 kg	
Prijs in €	excl. btw	€ 202,48	€ 161,16	€ 268,60	€ 86,78
	incl. btw	€ 245,00	€ 195,00	€ 325,00	€ 105,00

## DUH507 / DUH607 / DUH551

ACCU HEGGENSCHAREN



DUH607Z



DUH551Z



### DUH507 & DUH607:

- Budgetvriendelijke versies
- Compact en uiterst licht
- Versterkt krukmechanisme
- Handgreep met nieuw ontworpen schakelaar
- Hoogwaardige trillingsdemping

	DUH507Z	DUH507F001	DUH607Z	DUH607F001	DUH551Z	
Spanning	18V	18V	18V	18V	2 x 18V	
Bijgeleverde accu's	-	1x accu 3,0 Ah	-	1x accu 3,0 Ah	-	
Bijgeleverde lader	-	DC18WC	-	DC18WC	-	
BL motor	-	-	-	-	-	
Snijlengte	50 cm	50 cm	60 cm	60 cm	55 cm	
Maximale takdikte	15 mm	15 mm	15 mm	15 mm	18 mm	
Aantal snijbewegingen	2700 min <sup>-1</sup>	2700 min <sup>-1</sup>	2700 min <sup>-1</sup>	2700 min <sup>-1</sup>	2000-3600 min <sup>-1</sup>	
Max. uitgangsvermogen	250 W	250 W	250 W	250 W	320 W	
Gewicht	2,7 - 3,0 kg	2,7 - 3,0 kg	2,8 - 3,1 kg	2,8 - 3,1 kg	4,1 kg	
Prijs in €	excl. btw	€ 147,93	€ 214,05	€ 152,89	€ 222,31	€ 263,64
	incl. btw	€ 179,00	€ 259,00	€ 185,00	€ 269,00	€ 319,00

## DUH506 / DUH606

ACCU HEGGENSCHAREN 18 V



DUH606RF

### DUH506 & DUH606:

- Zeer efficiënt dankzij BL motor
- Compact en uiterst licht
- Versterkt krukmechanisme
- Handgreep met nieuw ontworpen schakelaar
- Hoogwaardige trillingsdemping

	DUH506Z	DUH506RF	DUH606Z	DUH606RF	
Spanning	18V	18V	18V	18V	
Bijgeleverde accu's	-	1x accu 3,0 Ah	-	1x accu 3,0 Ah	
Bijgeleverde lader	-	DC18RC	-	DC18RC	
BL motor	✓	✓	✓	✓	
Snijlengte	50 cm	50 cm	60 cm	60 cm	
Max. takdikte	20 mm	20 mm	20 mm	20 mm	
Aantal snijbewegingen	4000 min <sup>-1</sup>	4000 min <sup>-1</sup>	4000 min <sup>-1</sup>	4000 min <sup>-1</sup>	
Max. uitgangsvermogen	320 W	320 W	320 W	320 W	
Gewicht	2,5 - 2,9 kg	2,5 - 2,9 kg	2,7 - 3,0 kg	2,7 - 3,0 kg	
Prijs in €	excl. btw	€ 180,99	€ 288,43	€ 185,95	€ 296,69
	incl. btw	€ 219,00	€ 349,00	€ 225,00	€ 359,00

## DUH502 / DUH602 / DUH752

ACCU HEGGENSCHAREN 18 V



TANDEN MET KLASSIEKE GEOMETRIE



DUH502RT

		DUH502Z	DUH502RT	DUH602Z	DUH602RT	DUH752Z	DUH752RT
Spanning		18V	18V	18V	18V	18V	18V
Bijgeleverde accu's		-	1 x accu 5,0 Ah	-	1 x accu 5,0 Ah	-	1 x accu 5,0 Ah
Bijgeleverde lader		-	1 x DC18RC	-	1 x DC18RC	-	1 x DC18RC
BL motor		✓	✓	✓	✓	✓	✓
Snijlengte		50 cm	50 cm	60 cm	60 cm	75 cm	75 cm
Max. takdikte		21,5 mm	21,5 mm	21,5 mm	21,5 mm	21,5 mm	21,5 mm
Aantal snijbewegingen		2000 / 3600 / 4400 min <sup>-1</sup>	2000 / 3600 / 4400 min <sup>-1</sup>	2000 / 3600 / 4400 min <sup>-1</sup>	2000 / 3600 / 4400 min <sup>-1</sup>	2000 / 3600 / 4400 min <sup>-1</sup>	2000 / 3600 / 4400 min <sup>-1</sup>
Max. uitgangsvermogen		520 W	520 W	520 W	520 W	520 W	520 W
Gewicht		3,8 kg	3,8 kg	3,8 kg	3,8 kg	3,8 kg	3,8 kg
Prijs in €	excl. btw	€ 313,22	€ 412,40	€ 321,49	€ 445,45	€ 346,28	€ 478,51
	incl. btw	€ 379,00	€ 499,00	€ 389,00	€ 539,00	€ 419,00	€ 579,00

## DUH501 / DUH601 / DUH751 / DUH754S

ACCU HEGGENSCHAREN 18 V



**PROMO**

gratis DMR057 na online registratie DUH501RTE



TANDEN MET INNOVATIEVE GEOMETRIE

DUH501RTE



DUH754SZ  
(ENKELZIJDIG MES)

**INNOVATIEVE GEOMETRIE**

Beter snijresultaat  
Minder wrijving  
Grotere batterijautonomie

		DUH501Z	DUH501RTE	DUH601Z	DUH601PTE	DUH751Z	DUH751PTE	DUH754SZ
Uitvoering		Trim	Trim	Trim	Trim	Trim	Trim	Trim
Mes		Dubbelzijdig	Dubbelzijdig	Dubbelzijdig	Dubbelzijdig	Dubbelzijdig	Dubbelzijdig	Enkelzijdig
Bijgeleverde accu's		-	2 x accu 5,0 Ah	-	2 x accu 5,0 Ah	--	2 x accu 5,0 Ah	-
Bijgeleverde Lader		-	1 x DC18RC	-	1 x DC18RD	-	1 x DC18RD	-
BL motor		✓	✓	✓	✓	✓	✓	✓
Aantal snijbewegingen		2000/3600/4400 min <sup>-1</sup>	2000/3600/4400 min <sup>-1</sup>	2000/3600/4400 min <sup>-1</sup>	2000/3600/4400 min <sup>-1</sup>	2000/3600/4400 min <sup>-1</sup>	2000/3600/4400 min <sup>-1</sup>	2000/3600/4400 min <sup>-1</sup>
Snijlengte		50 cm	50 cm	60 cm	60 cm	75 cm	75 cm	75 cm
Max. takdikte		23,5 mm	23,5 mm	23,5 mm	23,5 mm	23,5 mm	23,5 mm	23,5 mm
Max. uitgangsvermogen		520 W	520 W	520 W	520 W	520 W	520 W	520 W
Gewicht		3,8 - 4,5 kg	3,8 - 4,5 kg	3,8 - 4,5 kg	3,8 - 4,5 kg	3,8 - 4,5 kg	3,8 - 4,5 kg	3,4 - 3,9 kg
Prijs in €	excl. btw	€ 326,45	€ 541,32	€ 338,02	€ 610,74	€ 362,81	€ 619,01	€ 511,57
	incl. btw	€ 395,00	€ 655,00	€ 409,00	€ 739,00	€ 439,00	€ 749,00	€ 619,00

### UH004G / UH005G

ACCU HEGGENSCHAREN 40VMAX 'TRIMVERSIE'



#### PROMO

gratis AS001GZ na online registratie UH004GM201 & UH005GM201



UH004GM201

		UH004GZ	UH004GM201	UH005GZ	UH005GM201
Uitvoering		Trim	Trim	Trim	Trim
Mes		Dubbelzijdig	Dubbelzijdig	Dubbelzijdig	Dubbelzijdig
Bijgeleverde accu's		-	2x BL4040	-	2x BL4040
Bijgeleverde lader		-	DC40RA	-	DC40RA
Aantal snijbewegingen		2000/3600/5000 min <sup>-1</sup>	2000/3600/5000 min <sup>-1</sup>	2000/3600/5000 min <sup>-1</sup>	2000/3600/5000 min <sup>-1</sup>
Snijlengte		60 cm	60 cm	75 cm	75 cm
Max. takdikte		23,5 mm	23,5 mm	23,5 mm	23,5 mm
Max. uitgangsvermogen		720 W	720 W	720 W	720 W
Gewicht		4,3 - 4,9 kg	4,3 - 4,9 kg	4,5 - 5,1 kg	4,5 - 5,1 kg
Prijs in €	excl. btw	€ 453,72	€ 891,74	€ 478,51	€ 908,26
	incl. btw	€ 549,00	€ 1.079,00	€ 579,00	€ 1.099,00

### UH006G / UH007G

ACCU HEGGENSCHAREN 40VMAX 'TERUGSNOEIVERSIE'



#### PROMO

gratis AS001GZ na online registratie UH006GM201 & UH007GM201



UH006GM201

		UH006GZ	UH006GM201	UH007GZ	UH007GM201
Uitvoering		Terugsnoei	Terugsnoei	Terugsnoei	Terugsnoei
Mes		Dubbelzijdig	Dubbelzijdig	Dubbelzijdig	Dubbelzijdig
Bijgeleverde accu's		-	2x BL4040	-	2x BL4040
Bijgeleverde lader		-	DC40RA	-	DC40RA
Aantal snijbewegingen		2000/3000/4000 min <sup>-1</sup>	2000/3000/4000 min <sup>-1</sup>	2000/3000/4000 min <sup>-1</sup>	2000/3000/4000 min <sup>-1</sup>
Snijlengte		60 cm	60 cm	75 cm	75 cm
Max. takdikte		25 mm	25 mm	25 mm	25 mm
Max. uitgangsvermogen		720 W	720 W	720 W	720 W
Gewicht		4,4 - 5,0 kg	4,4 - 5,0 kg	4,6 - 5,2 kg	4,6 - 5,2 kg
Prijs in €	excl. btw	€ 453,72	€ 891,74	€ 478,51	€ 908,26
	incl. btw	€ 549,00	€ 1.079,00	€ 579,00	€ 1.099,00

### UN460W / DUN461 / DUN500

ACCU STOKHEGGENSCHAREN (CXT/LXT)



DUN500WZ

DUN461WST

#### DUN500WZ ( 520 W)

- Instelbaar in 6 hoeken
- Dubbele greep voor extra comfort
- Innovatieve tandengeometrie
- Totale lengte: 2,1m

#### DUN461

- Klassieke tandengeometrie
- Telescopische steel 1,9m en 2,5m

		UN460WDZ	UN460WDWA	DUN461WZ	DUN461WST	DUN500WZ
Accuplatform		12Vmax (CXT)	12Vmax (CXT)	18 V (LXT)	18 V (LXT)	18 V (LXT)
Bijgeleverde accu's		-	1 x accu 2,0 Ah	-	1 x accu 5,0 Ah	-
Bijgeleverde lader		-	DC10WD	-	DC18SD	-
Snijlengte		46 cm	46 cm	46 cm	46 cm	50 cm
Maximale takdikte		18 mm	18 mm	18 mm	18 mm	23,5 mm
Totale lengte		1,889 - 2,511mm	1,889 - 2,511mm	1,889 - 2,511mm	1,889 - 2,511mm	2,115 mm
BL motor		-	-	-	-	✓
Aantal snijbewegingen		3600 min <sup>-1</sup>	3600 min <sup>-1</sup>	3600 min <sup>-1</sup>	3600 min <sup>-1</sup>	2000/3600/4400 min <sup>-1</sup>
Omkeerfunctie		✓	✓	✓	✓	✓
Gewicht		2,8 - 3,0 kg	2,8 - 3,0 kg	3,0 - 3,3 kg	3,4 kg	3,9 - 4,3 kg
Prijs in €	excl. btw	€ 156,20	€ 247,11	€ 164,46	€ 304,96	€ 395,87
	incl. btw	€ 189,00	€ 299,00	€ 199,00	€ 369,00	€ 479,00

## LM001C

GRASMAAIER MET RECHTSTREEKSE VOEDING VIA ACCUPACK



3 INSTELLINGEN :  
- STANDAARD  
- SOFT NO LOAD  
- STILLE WERKING



LM001CZ



ENERGIEZUINIG MESONTWERP (onderkant toestel)

**BL MOTOR** **XPT** **SOFT NOLOAD**  
EXTREME PROTECTION TECHNOLOGY



LM001C MET MONTAGE VAN PDC01 / PDC1200 (Draagbaar accupack niet inbegrepen)

		LM001CZ
Platform		Accupack
Max. uitgangsvermogen		1600 W
Maaibreedte		53 cm
Maaihogte		20 - 100 mm
Inhoud opvangbak		70 l
Mulching		✓
Zelftrekkend		✓
Chassis		Staal
Aanbevolen oppervlakte		1500 - 3000 m <sup>2</sup>
Gewicht		41,9 kg
Prijs in €	excl. btw	€ 1.309,92
	incl. btw	€ 1.585,00

### ACCESSOIRES BIJ DRAAGBAAR ACCUPACK

Adapter:  
ref. 191N62-4  
€ 170,90 excl. btw  
€ 206,79 incl. btw



**Niet alleen voor gebruik met machines met directe aansluiting**

Ook standaard machines die werken met 40Vmax, 2 x 18V of 18V accu's kunnen op het accupack aangesloten worden middels de juiste adapter.

Adapter:  
ref. 191J51-5  
€ 177,90 excl. btw  
€ 215,26 incl. btw



Adapter:  
ref. 191J50-7  
€ 122,50 excl. btw  
€ 148,23 incl. btw



### PDC1200

met geïntegreerde accu voor 36V/40Vmax



### PDC01

kan tot 4 18V accu's bevatten

Werkt uitsluitend met Makita's draagbare accupack

## UV3200 / UV3600

ELEKTRISCHE VERTICUTEERMACHINES



UV3200



UV3600

		UV3200	UV3600
Nominaal vermogen		1300 W	1800 W
Werkbreedte		32 cm	36 cm
Polypropyleen chassis		✓	✓
Gewicht		15 kg	18,3 kg
Prijs in €	excl. btw	€ 185,95	€ 271,90
	incl. btw	€ 225,00	€ 329,00

## DLM536 / DLM533

ACCU GRASMAAIERS 2 x 18V

**PROMO**

Gratis BL1850B na online registratie



DLM536Z



DLM533Z

		DLM536Z	DLM533Z
Spanning		2x 18V	2x 18V
Bijgeleverde lader		-	-
Bijgeleverde accu's		-	-
Max. uitgangsvermogen		1600 W	1600 W
Maibreedte		53 cm	53 cm
Aanbevolen terreinoppervlakte		1600 - 1800 m <sup>2</sup>	1600 - 1800 m <sup>2</sup>
Chassis		Staal	Aluminium
Zelftrekkend		✓	✓
Inhoud opvangbak		60 l	60 l
Mulching		✓	✓
Gewicht		39,0 - 42,8 kg	39,0 - 42,8 kg
Prijs in €	excl. btw	<b>€ 933,06</b>	<b>€ 1.313,22</b>
	incl. btw	<b>€ 1.129,00</b>	<b>€ 1.589,00</b>

## LM001G / LM002G

ACCU GRASMAAIERS 40VMAX



**PROMO**

Gratis BL4040 direct geleverd bij LM001GZ & LM002GZ



3 snelheden: standaard, stil en automatisch (soft no load).

Nieuwe krachtige BL-motor met buitenrotor, speciaal ontwikkeld voor grasmaaiers.

Voeding met twee XGT accu's in parallel (36V). Automatische overschakeling wanneer één accu leeg is

Grote wielen Ø 230 mm voor betere tractie en comfortabel rijden op oneffen terrein.

Robuust stalen maaidek

Traploos regelbare snelheid met groot bereik (0,5 tot 1,5 km/h).

Stevige duwhendel opvouwbaar zonder gereedschap.

Grote opvangcapaciteit. Standaard met mulching plug en een plug voor grasuitworp achteraan.

Wetguard/IPX/4 compatibel Constructie met uitstekende bestendigheid tegen indringing van water.

Het standaard mes is geschikt voor mulchen en grasopvang. Speciale maaimessen zijn afzonderlijk verkrijgbaar

		LM001GZ	LM002GZ
Spanning		36 V (40Vmax)	36 V (40Vmax)
Max. uitgangsvermogen		1900 W	1900 W
Maibreedte		48 cm	53 cm
Aanbevolen terreinoppervlakte		1600 - 1800 m <sup>2</sup>	1700 - 2000 m <sup>2</sup>
Toerental onbelast		2500 / 3200 min <sup>-1</sup>	2300 / 2800 min <sup>-1</sup>
Maaihoogte		20 - 100 mm	20 - 100 mm
Rijsnelheid		1,5 - 5,0 km/h	1,5 - 5,0 km/h
Opvangcapaciteit		62 l	70 l
Gewicht		28,0 - 33,0 kg	29,5 - 34,7 kg
Prijs in €	excl. btw	<b>€ 908,26</b>	<b>€ 990,91</b>
	incl. btw	<b>€ 1.099,00</b>	<b>€ 1.199,00</b>

### DLM330

ACCU GRASMAAIERS 18V



DLM330SM

	DLM330Z	DLM330SM
Spanning	1 x 18V	1 x 18V
Bijgeleverde accu's	-	1 x accu 4,0 Ah
Bijgeleverde Lader	-	DC18SD
Max. uitgangsvermogen	450 W	450 W
Maaibreedte	33 cm	33 cm
Aanbevolen terreinoppervlakte	200 - 450 m <sup>2</sup>	200 - 450 m <sup>2</sup>
Chassis	Polypropyleen	Polypropyleen
Zelftrekkend		
Inhoud opvangbak	30 l	30 l
Mulching	✓	✓
Gewicht	11,6 - 12,5 kg	11,6 - 12,5 kg
Prijs in €	excl. btw	€ 185,95
	incl. btw	€ 225,00

### DLM432

ACCU GRASMAAIERS 2 x 18V



DLM432PT2

	DLM432Z	DLM432PT2
Spanning	2 x 18V	2 x 18V
Bijgeleverde accu's	-	2 x accu 5,0 Ah
Bijgeleverde Lader	-	DC18RD
Max. uitgangsvermogen	900 W	900 W
Maaibreedte	43 cm	43 cm
Aanbevolen terreinoppervlakte	300 - 575 m <sup>2</sup>	300 - 575 m <sup>2</sup>
Chassis	Polypropyleen	Polypropyleen
Zelftrekkend	-	-
Inhoud opvangbak	50 l	50 l
Mulching	Optioneel	Optioneel
Gewicht	14,3 kg	14,3 kg
Prijs in €	excl. btw	€ 384,30
	incl. btw	€ 465,00

"Max aanbevolen maaiooppervlakte" is de maximum oppervlakte waar de machine qua vermogen, mechaniek en werkbreedte voor geschikt is. Opgelet, dit komt niet noodzakelijk overeen met de autonomie, die afhankelijk is van het type batterijen dat gebruikt wordt en de maaiomstandigheden (de hoogte en dichtheid van het gras, de helling van het terrein enz.) Dus het kan voorkomen dat de accu's tussenin bijgeladen moeten worden om de volledige oppervlakte te kunnen maaien.

### DLM480 / DLM481 / DLM539

ACCU GRASMAAIERS 2 x 18V

**PROMO**

Gratis BL1850B na online registratie DLM481CT2 en DLM539CT2



DLM481CT2



DLM539CT2

	DLM480CT2	DLM481CT2	DLM539CT2
Spanning	2 x 18V	2 x 18V	2 x 18V
Bijgeleverde accu's	2 x accu 5,0 Ah	2 x accu 5,0 Ah	2 x accu 5,0 Ah
Bijgeleverde Lader	DC18SH	DC18SH	DC18SH
Max. uitgangsvermogen	860 W	860 W	860 W
Maaibreedte	48 cm	48 cm	53,4 cm
Aanbevolen terreinoppervlakte	400 - 800 m <sup>2</sup>	400 - 800 m <sup>2</sup>	500 - 1000 m <sup>2</sup>
Chassis	Polypropyleen	Polypropyleen	Polypropyleen
Zelftrekkend	-	✓	✓
Inhoud opvangbak	62 l	62 l	70 l
Mulching	✓	✓	✓
Gewicht	24,5 - 26,8 kg	27,1 - 29,3 kg	28,0 - 30,5 kg
Prijs in €	excl. btw	€ 701,65	€ 784,30
	incl. btw	€ 849,00	€ 949,00

### DLM463 / DLM465

ACCU GRASMAAIERS 2 x 18V

**PROMO**

Gratis BL1850B na online registratie



NIEUW

NIEUW

NIEUW

NIEUW



DLM463PT2

DLM465PT2

	DLM463Z	DLM463PT2	DLM465Z	DLM465PT2
Spanning	2x 18V	2x 18V	2x 18V	2x 18V
Bijgeleverde accu's	-	2x 5,0 Ah	-	2x 5,0 Ah
Bijgeleverde lader	-	DC18RD	-	DC18RD
Max. uitgangsvermogen	1450 W	1450 W	1600 W	1600 W
Maaibreedte	46 cm	46 cm	46 cm	46 cm
Aanbevolen terreinoppervlakte	800 - 1600 m <sup>2</sup>	800 - 1600 m <sup>2</sup>	1600 - 1800 m <sup>2</sup>	1600 - 1800 m <sup>2</sup>
Chassis	Staal	Staal	Staal	Staal
Zelftrekkend	-	-	✓	✓
Inhoud opvangbak	60 l	60 l	60 l	60 l
Mulching	✓	✓	✓	✓
Gewicht	25,3 - 27,6 kg	25,3 - 27,6 kg	35,3 - 39,0 kg	35,3 - 39,0 kg
Prijs in €	excl. btw	€ 594,21	€ 866,94	€ 1.156,20
	incl. btw	€ 719,00	€ 1.049,00	€ 1.399,00



### UB101D

ACCU BLAZER 12VMAX



#### UB101DZ

Spanning	10,8V (12Vmax)	
Bijgeleverde accu's	-	
Bijgeleverde lader	-	
Luchtsnelheid	65 m/s	
Max. debiet	2,6 m³/min	
Max. blaaskracht	1,6 N	
Gewicht	1,4 - 1,9 kg	
Prijs in €	excl. btw	€ 65,29
	incl. btw	€ 79,00

### DUB186

ACCU BLAZER 18V



#### DUB186Z

Spanning	18V	
Bijgeleverde accu's	-	
Bijgeleverde lader	-	
Luchtsnelheid	56 m/s	
Max. debiet	3,2 m³/min	
Max. blaaskracht	2,5 N	
Gewicht	1,6 - 2,1 kg	
Prijs in €	excl. btw	€ 65,29
	incl. btw	€ 79,00

### DUB184

ACCU BLADBLAZER 18V



#### DUB184Z

#### DUB184RT

Spanning	18V	18V	
Bijgeleverde accu's	-	1 x BL1850B	
Bijgeleverde lader	-	DC18RC	
Luchtsnelheid	49 m/s	49 m/s	
Max. debiet	12,7 m³/min	12,7 m³/min	
Max. blaaskracht	10,9 N	10,9 N	
Gewicht	2,5 - 3,0 kg	2,5 - 3,0 kg	
Prijs in €	excl. btw	€ 144,63	€ 263,64
	incl. btw	€ 175,00	€ 319,00

### DUB362

ACCU BLADBLAZER 2 x 18V



#### DUB362Z

#### DUB362TX1

Spanning	2x18V	2x18V	
Bijgeleverde accu's	-	4 x BL1850B	
Bijgeleverde lader	-	DC18RD	
Luchtsnelheid	54 m/s	54 m/s	
Max. debiet	13,4 m³/min	13,4 m³/min	
Max. blaaskracht	14,4 N	14,4 N	
Gewicht	3,5 - 4,2 kg	3,5 - 4,2 kg	
Prijs in €	excl. btw	€ 255,37	€ 693,39
	incl. btw	€ 309,00	€ 839,00

### UB001G

ACCU BLADBLAZER 40VMAX



### PROMO

gratis AS001GZ na online registratie UB001GM101



#### UB001GZ

#### UB001GM101

Spanning	36V (40Vmax)	36V (40Vmax)	
Bijgeleverde accu's	-	1x BL4040	
Bijgeleverde lader	-	DC40RA	
Luchtsnelheid	64 m/s	64 m/s	
Max. debiet	16,0 m³/min	16,0 m³/min	
Max. blaaskracht	12 N (17 N boost)	12 N (17 N boost)	
Gewicht	3,1 - 3,9 kg	3,1 - 3,9 kg	
Prijs in €	excl. btw	€ 280,17	€ 544,63
	incl. btw	€ 339,00	€ 659,00

### DUB363

ACCU BLADBLAZER / -ZUIGER 2 x 18V



Geleverd met bladzuigset

#### DUB363ZV

Spanning	2 x 18V	
Bijgeleverde accu's	-	
Bijgeleverde lader	-	
Luchtsnelheid	54 m/s	
Max. debiet	13,4 m³/min	
Max. blaaskracht	14,4 N	
Gewicht	4,5 - 6,6 kg	
Prijs in €	excl. btw	€ 326,45
	incl. btw	€ 395,00

## DUB187

ACCU BLADBLAZER / - ZUIGER 18V



- Budgetvriendelijke bladzuiger / blazer
- Variabele snelheid en "cruise control" (aanhouden gekozen snelheid)
- Turbine met verhaakselmes
- Omschakelen van zuigen naar blazen met slechts één hendel



DUB187T001

**NIEUW**

**NIEUW**

**DUB187Z**

**DUB187T001**

Spanning	18V	18V
Bijgeleverde accu's	-	BL1850B
Bijgeleverde lader	-	DC18WC
Luchtsnelheid (blazen)	64 m/s	64 m/s
Max. debiet (zuigen)	6,1 m <sup>3</sup> /min	6,1 m <sup>3</sup> /min
Max. onderdruk	33 mbar	33 mbar
Max. blaaskracht	4,2 N	4,2 N
Gewicht	3,7 - 4,0 kg	3,7 - 4,0 kg
Prijs in €	excl. btw	€ 194,21
	incl. btw	€ 235,00
Prijs in €	excl. btw	€ 285,12
	incl. btw	€ 345,00

### Optioneel accessoire

**GB00000165**

T-vormig mondstuk  
geschikt voor DUB187  
€ 7,50 (excl. btw) / € 9,08 (incl. btw)



## UB001CZ

BLADBLAZER MET DIRECTE  
AANSLUITING OP ACCUPACK



ENKEL AANSLUITBAAR OP  
DRAAGBAAR ACCUPACK  
PDC/01 / PDC1200

AANGEPASTE  
LUCHTSTROOM VOOR  
BETERE PRESTATIES EN  
MEER  
GEBRUIKSGEMAK  
LAAG GELUIDSNIVEAU



**UB001CZ**

Platform	Accupack PDC01 of PDC1200	
Max. luchtsnelheid	70 m/s	
Max. debiet	17,6 m <sup>3</sup> /min	
Max. blaaskracht	15 N (20 N boost)	
Gewicht	2,6 kg	
Prijs in €	excl. btw	€ 395,87
	incl. btw	€ 479,00

## UB002CZ

RUGGEDRAGEN BLADBLAZER MET  
RECHTSTREEKSE AANSLUITING OP ACCUPACK

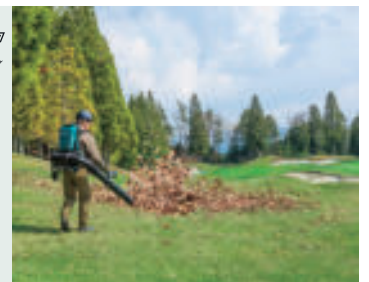

ACCU NIET  
INBEGREPEN !



Het accupack kan in één  
beweging op de machine  
vastgeklkt worden.



Triggerschakelaar met  
variabele snelheid en "cruise  
control" hendel.



De bedieningshendel kan  
horizontaal verschoven en  
gekanteld worden.

**UB002CZ**

Platform	Accupack PDC1200	
Luchtsnelheid	71,7 m/s	
Max. debiet	19 m <sup>3</sup> /min	
Max. blaaskracht	20 N (22 N boost)	
Geluidsdrukkniveau	81 dB (A)	
Gewicht	15,9 - 16,1 kg	
Prijs in €	excl. btw	€ 607,44
	incl. btw	€ 735,00

### DLX4181PT2

ACCU COMBOPACK TUIN

36V

18V LITHIUM-ION

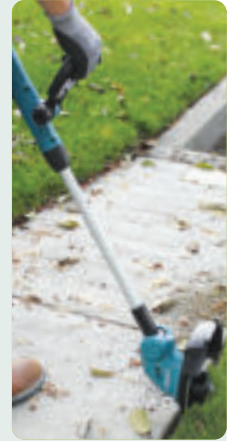

#### DLX4181PT2

Bijgeleverde accu's	2 x accu 5,0 Ah	
Duo snellader	DC18RD	
Heggenschaar	DUH507	
Bladblazer	DUB184	
Gastrimmer	DUR193	
Grasmaaier	DLM432	
Prijs in €	excl. btw	€ 866,94
	incl. btw	€ 1049,00

### DLX5057PTJ

ACCU COMBOPACK TUIN

36V

XPT

BL MOTOR

18V LITHIUM-ION



#### DLX5057PTJ

Bijgeleverde accu's	4 x accu 5,0 Ah	
Duo snellader	DC18RD	
Heggenschaar	DUH601	
Kettingzaag	DUC353	
Gastrimmer	DUR368	
Grasmaaier	DLM463	
Bladblazer	DUB362	
Prijs in €	excl. btw	€ 2.065,29
	incl. btw	€ 2.499,00